

Contemporary Outdoor

POINT.

Sentarnos afuera y sentirnos adentro. O viceversa. Hay muebles que eliminan fronteras y estrechan lazos. Salones que salen al jardín, terrazas que entran en casa. Esa es la magia de POINT, su capacidad de prolongar el hogar en nuestros espacios exteriores y de ser un soplo de aire puro que se cuela para crear ambientes naturales.

Imagine sitting outside and feeling like you're inside. Or vice versa. Furniture capable of doing away with barriers and strengthening connections. Rooms that make their way out into the gardens and patios that feel like a part of the home. This is POINT's magic, its ability to extend the home into our outdoor spaces and be a breath of fresh air that manages to sneak its way in and create natural environments.

Outdoor living

En 1919, cuando sentarse afuera era coger la silla más viejecita de la casa y salir al porche, POINT llegó para aportar estilo a nuestros jardines y terrazas. Hoy, un siglo después, continúa invitándonos a vestir nuestros exteriores con el mismo mimo que cuidamos el interior del hogar. Y lo hace con sus muebles contemporáneos de diseños puros, integrados en la naturaleza, hechos artesanalmente con materiales resistentes a la intemperie y con las líneas ergonómicas que exigen los momentos de relax.

In 1919, when sitting outside meant taking the oldest chair from your home and heading out to the porch, POINT made its debut, adding some much-needed style to our gardens and patios. Today, a century later, it continues to invite us to liven up our outdoor spaces with the same amount of dedication we put into decorating the inside of the home. And it does so thanks to its fresh designs and contemporary furniture that is handmade with weatherproof materials and easily integrates into nature, with ergonomic lines that are so important when it comes to our relaxation.

Point Contemporary

Tumbonas, sofás, sillas, mesas de maderas tropicales, aluminio, hierro o lo último en fibras que destacan por su frescura y su confort. Muebles de autor firmados por grandes diseñadores que suben el grado de la decoración en hogares, espacios contract y hospitality para que vivamos los exteriores con estilo.

Con POINT, las tendencias salen de casa y lo hacen por la puerta grande, creando espacios mágicos y confortables que completan nuestro deseo innato de conectar con nuestro yo más natural. Ambientes en los que el tiempo parece detenerse y cabe todo menos el estrés. ¿Salimos?

Sun loungers, sofas, chairs, tables made of tropical wood, aluminium, iron, or the latest in fibres that are known for how fresh and comfortable they are. High-end furniture made by the best designers who take things to a whole new level when it comes to decorating homes, contract and hospitality spaces, allowing us to dress up our outdoor spaces in style.

With POINT, trends leave our homes and make their exit through the front door, creating magical and comfortable spaces that complete our innate desire to connect with our most natural self. Environments in which time seems to stand still and everything but stress is welcome. Shall we head outside?

A new perspective



POINT cumple un siglo y tres generaciones. Pocas empresas pueden decir lo mismo. La marca referente internacional en mobiliario de exterior celebra sus 100 años de una historia trenzada a mano. En cada hilo, en cada nudo, en cada recodo de sus formas se pueden leer, como prismas de su tiempo, todo el diseño, la evolución y la cultura del mueble de fibra y ratán elaborado en España.

Las modas pasan, los gustos de los consumidores evolucionan, los materiales se amplían y los diseños se renuevan incesantemente. Pero la esencia de POINT ha permanecido durante tres generaciones, prolongando nuestros hogares al aire libre y haciendo confortables jardines, terrazas, hoteles y restaurantes. Hoy, como hace un siglo, son sus muebles los que hablan de POINT, de su pureza, de su bienestar y de su filosofía, difundiendo por todo el mundo la cultura que hay detrás de ellos.

POINT is turning 100 years old, having passed through the hands of three generations. Few companies can say the same. The international leader in outdoor furniture is celebrating 100 years of handwoven history. Each and every thread, knot, and shape acts like a prism through which you can perceive the design, evolution and culture of their woven fibre and rattan furniture that is made exclusively in Spain.

Trends come and go, consumer tastes evolve, materials improve and designs are constantly being renewed. But POINT's essence has remained the same for three generations, bringing our homes into the outdoors and making sure our gardens, terraces, hotels and restaurants are as comfortable as possible. Today, just like a century ago, POINT's furniture speaks for itself, it speaks of the brand's purity, wellbeing and philosophy, spreading the culture behind this furniture all over the world.



**Nika Zupanc**

Trabaja como diseñadora de producto e interiores para grandes firmas internacionales. Su peculiar estilo da lugar a creaciones con una gran carga emocional además de un exquisito acabado. Entre sus premios figuran el de Diseño Alemán en 2018 por Crystal Lamp para Contardi Lighting, el Premio Especial del Salone del Mobile en 2017 por el proyecto Tracing Identity para Castelli o el Premio ICFE en 2015 al mejor mobiliario por Collection III for Se.

She works as a product and interior designer for large international companies. Her peculiar style gives rise to creations that are emotionally charged with an exquisite finish. Some of the prizes she has received include the German Design Award in 2018 for the Crystal Lamp for Contardi Lighting, the Special Prize at the Salone del Mobile in 2017 for the Tracing Identity project for Castelli, or the ICFE Best Furniture Award in 2015 for the Collection III for Se.

**Francesc Rifé**

Inconformista por naturaleza, en 1994 funda su propio estudio en Barcelona. Sus proyectos, nacionales e internacionales, abarcan desde el interiorismo al diseño industrial en el sector comercial y el privado. Durante su trayectoria ha obtenido varios premios de diseño como los Contract World Awards, ICFE Editors Awards, Premios FAD y Premios ASCER y ha sido finalista en los Premios Nacionales de Diseño y los Delta, entre otros.

Nonconformist by nature, in 1994 he founded his own studio in Barcelona. His projects, both national and international, range from interior design to industrial design in the commercial and private sectors. Throughout his career, he has won several design awards such as the Contract World Awards, ICFE Editors Awards, FAD Awards and the ASCER Awards, and he was a finalist at the National Design Awards and the Delta Awards, among others.

**Gabriel Teixidó**

Diseñador industrial merecedor de numerosos premios. Delta de Plata en 1992 y 1997, Premio de Diseño Industrial del Consell de Cambres de Catalunya, Premio Nuevo Estilo y Premios Sidi.

Industrial designer who has won many awards. Silver Delta Award in 1992 and 1997, Industrial Design Award by the Council of the Catalan Chambers of Commerce, New Style Award and Sidi Awards.

**Vicent Martínez**

Reconocido diseñador con varias nominaciones Adi Fad así como premios Impiva, Nuevo Estilo y Sidi. En 1997 se le otorgó el Premio Nacional de Diseño de España en su categoría de Empresa. Sus diseños se incluyen en publicaciones, colecciones privadas y en las colecciones permanentes del Museu del Disseny, Barcelona, Museum für Angewandte Kunst de Colonia y en el Staatliches Museum Für Angewandte de Munich.

Recognized designer with several Adi Fad nominations, as well as the Impiva, Nuevo Estilo and Sidi awards. In 1997, he won the National Design Award of Spain in its Enterprise category. His designs have been included in publications, private collections and the permanent collections at the Museu del Disseny (Barcelona), the Museum für Angewandte Kunst (Cologne), and the Staatliches Museum Für Angewandte (Munich).

**Studi{H}ac**

Es un atelier de diseño reconocido por su talento creativo y su trayectoria multidisciplinar. Fundado en 2003 por José Manuel Ferrero, realizan proyectos de arquitectura interior, diseño de producto y creación de montajes efímeros para instalaciones.

A design atelier recognized for its creative talent and multidisciplinary trajectory. Founded in 2003 by José Manuel Ferrero, they carry out interior architecture projects, product design and the creation of ephemeral assemblies for installations.

**Juan Santos**

De formación autodidacta, diseña y realiza todo tipo de mobiliario desde hace más de 15 años. La verdadera representación del diseñador enamorado de su oficio, que acompaña y supervisa cada pieza desde su creación hasta ver el producto y su idea hecha realidad.

Self-taught, he has been designing and making all kinds of furniture for more than 15 years. The true representation of the designer who is love with his craft, who accompanies and supervises each piece from its creation all the way through to when the product and idea finally come to life.

**Joaquín Homs**

Arquitecto e interiorista, diseña a partir del espacio, no del objeto. Piensa de lo general a lo particular y no sigue estilos determinados. Prefiere entender las necesidades de la gente y buscar una solución. Es co-fundador de “Colectivo Arquitectos” de México, especialista en diseño residencial y hostelería y ha desarrollado grandes proyectos turísticos por todo el mundo.

Architect and interior designer, he designs from the space, not the object. His thinking goes from the more general to the more specific and he does not follow any certain style. He prefers to understand the needs of people and look for a solution. He is the co-founder of “Colectivo Arquitectos” in Mexico, a specialist in residential design and hospitality, and has developed large tourism projects all around the world.

**Esther Campos**

Diseñadora industrial y responsable del departamento de diseño de POINT.

Industrial designer and head of the Design Department at POINT.

Index



p. 122

Arc

Gabriel Teixidó

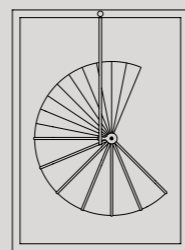

p. 198

Armadillo

Joaquín Homs

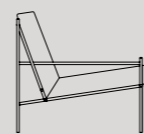

p. 14

Min ^{NEW}

Francesc Rifé



p. 208

Mist

Estudi{H}ac

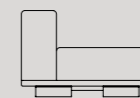

p. 84

Pal

Francesc Rifé

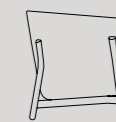

p. 148

Round

Francesc Rifé

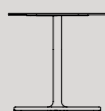

p. 202

Colors

Gabriel Teixidó



p. 30

Dalmatia ^{NEW}

Nika Zupanc



p. 140

Fennec

Gabriel Teixidó

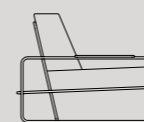

p. 44

Sir ^{NEW}

Francesc Rifé



p. 194

Sunset

Esther Campos



p. 52

T ^{NEW}

Gabriel Teixidó



p. 106

Tub

Gabriel Teixidó



p. 94

Hamp

Francesc Rifé

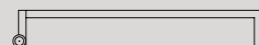

p. 134

Jazz

Point Studio

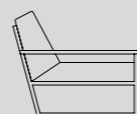

p. 116

Lineal

Gabriel Teixidó



p. 176

U

Gabriel Teixidó

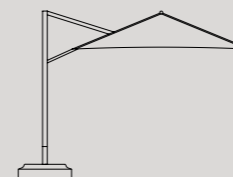

p. 212

Umbrellas

Point Studio



p. 60

Weave

Vicent Martínez

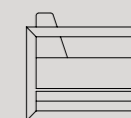

p. 160

Weekend

Juan Santos

NEW

Min

Francesc Rifé

Las cintas tensadas en los respaldos y en las bases de los muebles de esta colección nos traen bellos recuerdos de otros tiempos. Ahora también forman parte del mobiliario más moderno de exterior y su aire retro contrasta con las estilizadas líneas de aluminio que vertebran la serie Min.

With bands stretched across the backrests and bases of the furniture in this collection, we are flooded with beautiful memories of times past. As part of the most modern outdoor furniture, their retro air creates a unique contrast against the stylised aluminium lines that make up the backbone of the Min series.





In page 15, armchair, sofa 2 and coffee table 100x100 in cream 34 and table top in natural white 81.

On the previous and the current page, dining armchair and dining table 200x100 in sand 74 and table top in natural white 81.



On the current page, armchair and sofa 2 in green ficus 73.

On the next page, dining armchair and dining table 90x90 in oxide 75 and table top in lava grey 82.

In pages 20-21, armchair, sofa 3 and coffee table 100x100 in cream 34 and table top in natural white 81.







Armchair and corner table in oxide 75
and table top in corten 83.



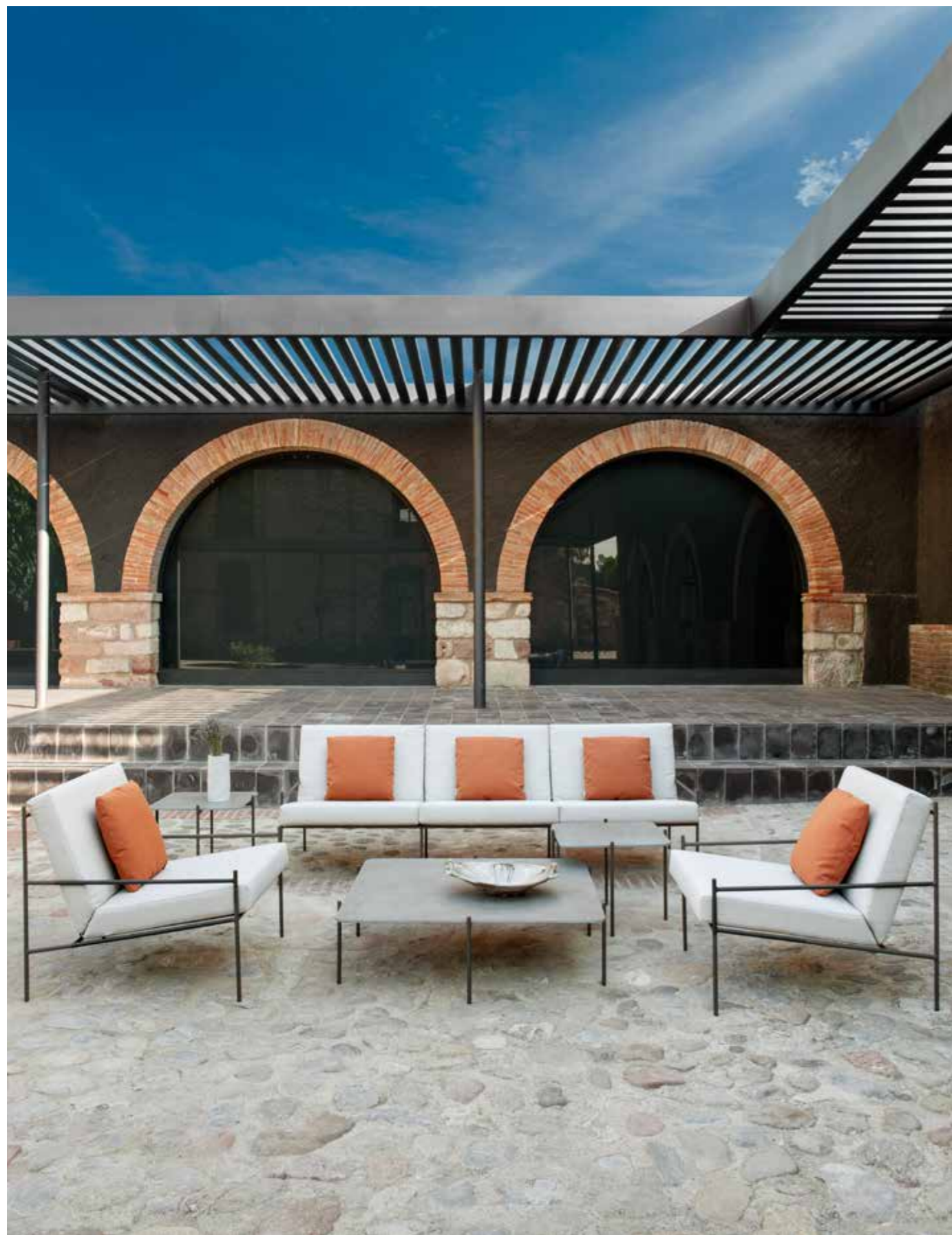

Armchair, sofa 3, coffee table 100x100 and corner table in gunmetal grey 56 and table top in light grey 80.



Dining armchair and dining table
200x100 in cream 34 and table
top in natural white 81.

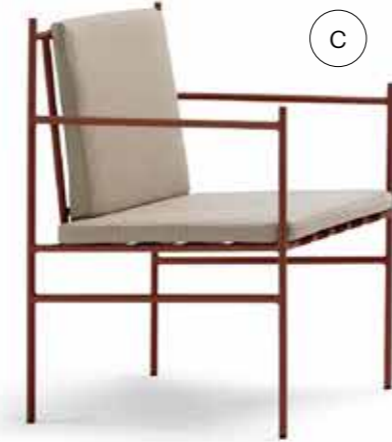

A White snow 70.
Blanco nieve 70.

B Green ficus 73.
Verde ficus 73.

C Terracotta 72.
Terracota 72.

D Gunmetal grey 56.
Gris metalizado 56.

E Blue sky 71.
Azul cielo 71.

F Sand 74.
Arena 74.

G Cream 34.
Crema 34.

H Oxide 75.
Óxido 75.

NEW

Dalmatia

Nika Zupanc

Los veranos junto al mar Adriático, la blancura de las piedras de sus playas o el color púrpura oscuro de la madera de sus pinos inspiran las líneas sinuosas y delicadas de la colección Dalmatia. Un perfecto equilibrio entre innovación, tecnología y diseño en una colección de exterior en aluminio que destaca por la frescura de sus líneas, su confort y su solidez.

Summers by the Adriatic Sea, the whiteness of the stones on the beach, or the dark purple of the wood from pine trees, this is what inspired the sinuous and delicate lines of the Dalmatia collection. A perfect balance between innovation, technology and design in an outdoor aluminium collection, which stands out thanks to the freshness of its lines, its comfort and its strength.

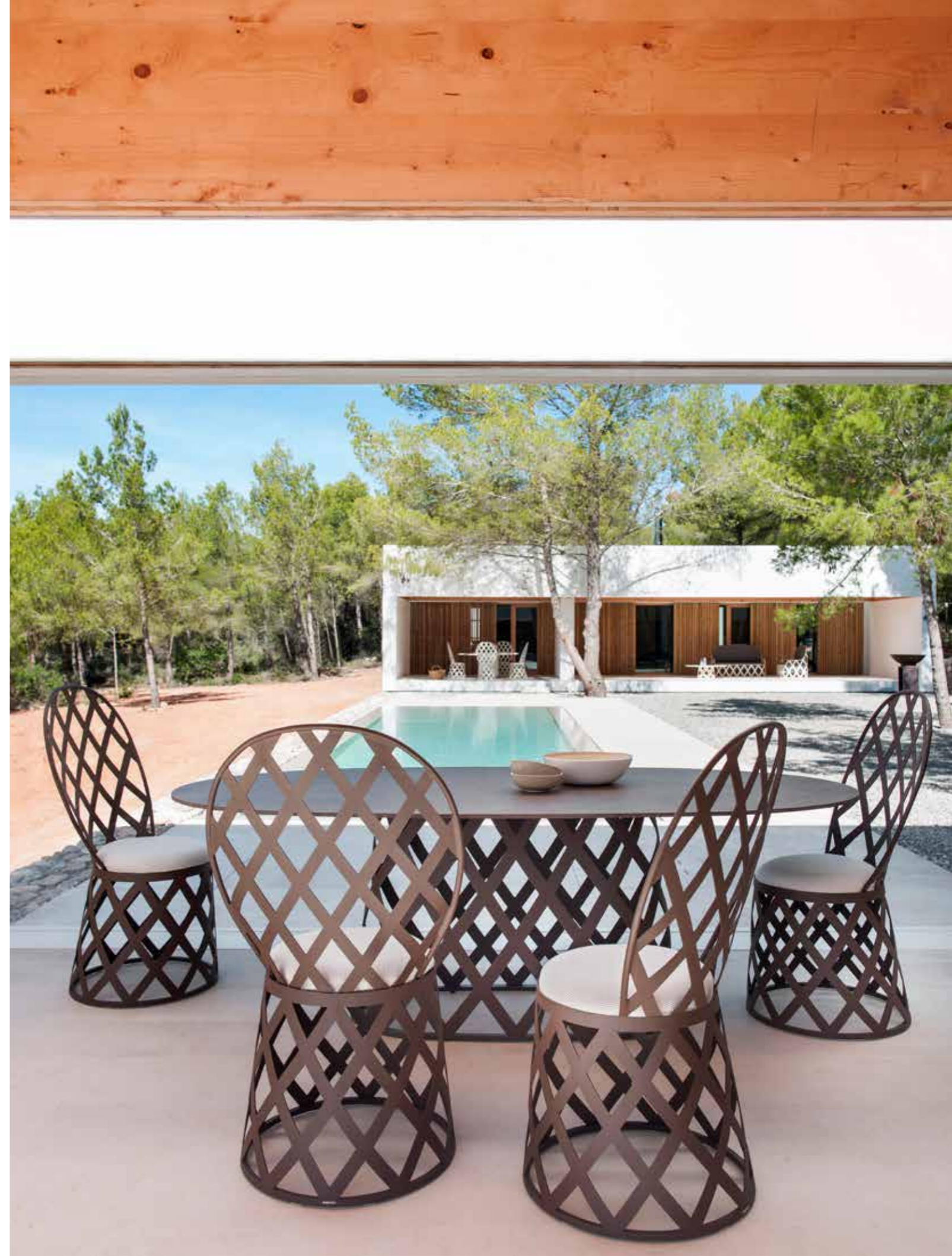



In page 31, chair and oval dining table in oxide 75 and table top in corten 83.

On the current page, chair and round dining table in white snow 70 and table top in natural white 81.



Chair in blue sky 71.

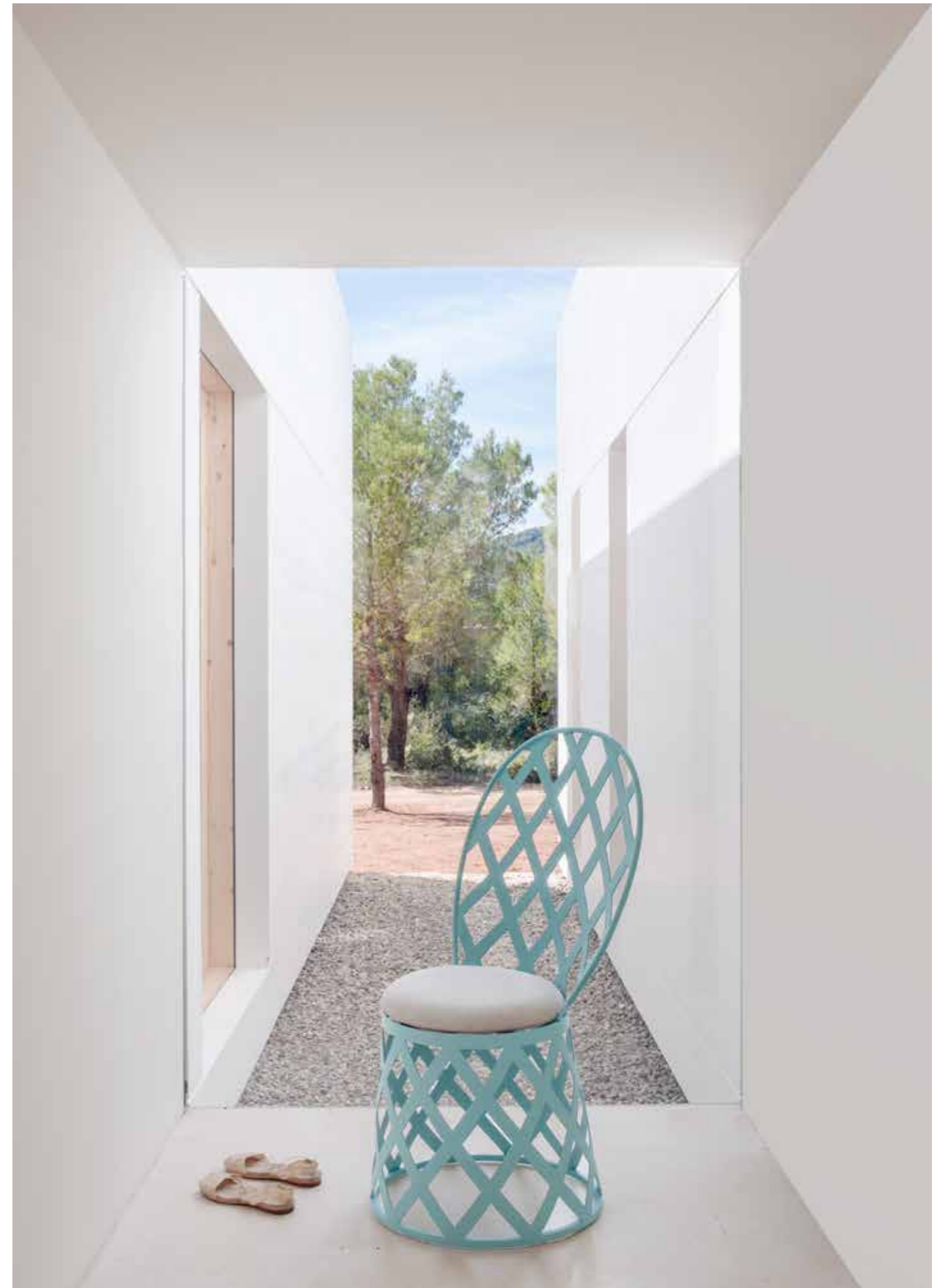

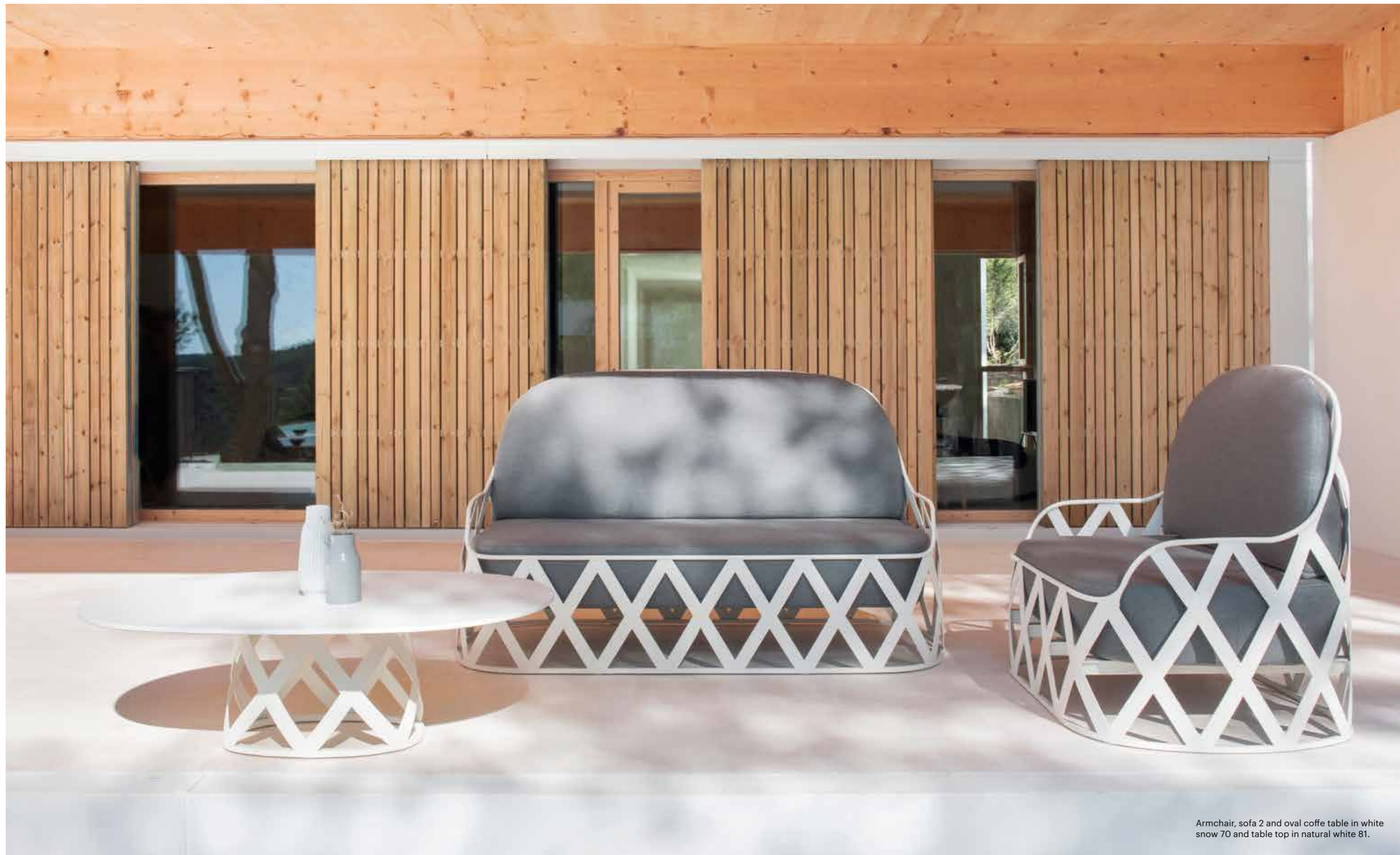

Armchair, sofa 2 and oval coffee table in white snow 70 and table top in natural white 81.

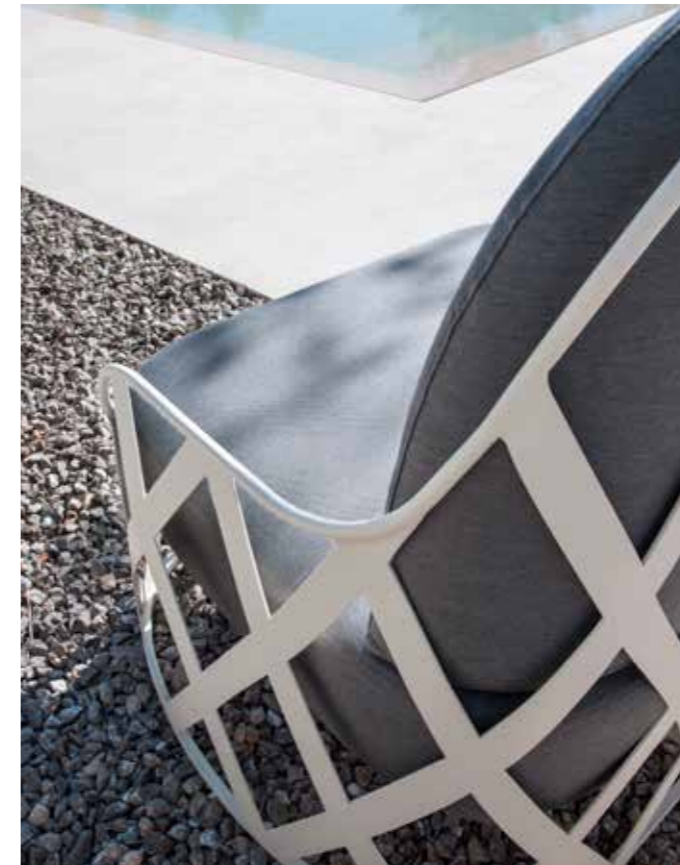

On the previous page, armchair in blue sky 71.

On the current page, armchair in white snow 70.



Armchair XL in white snow 70.

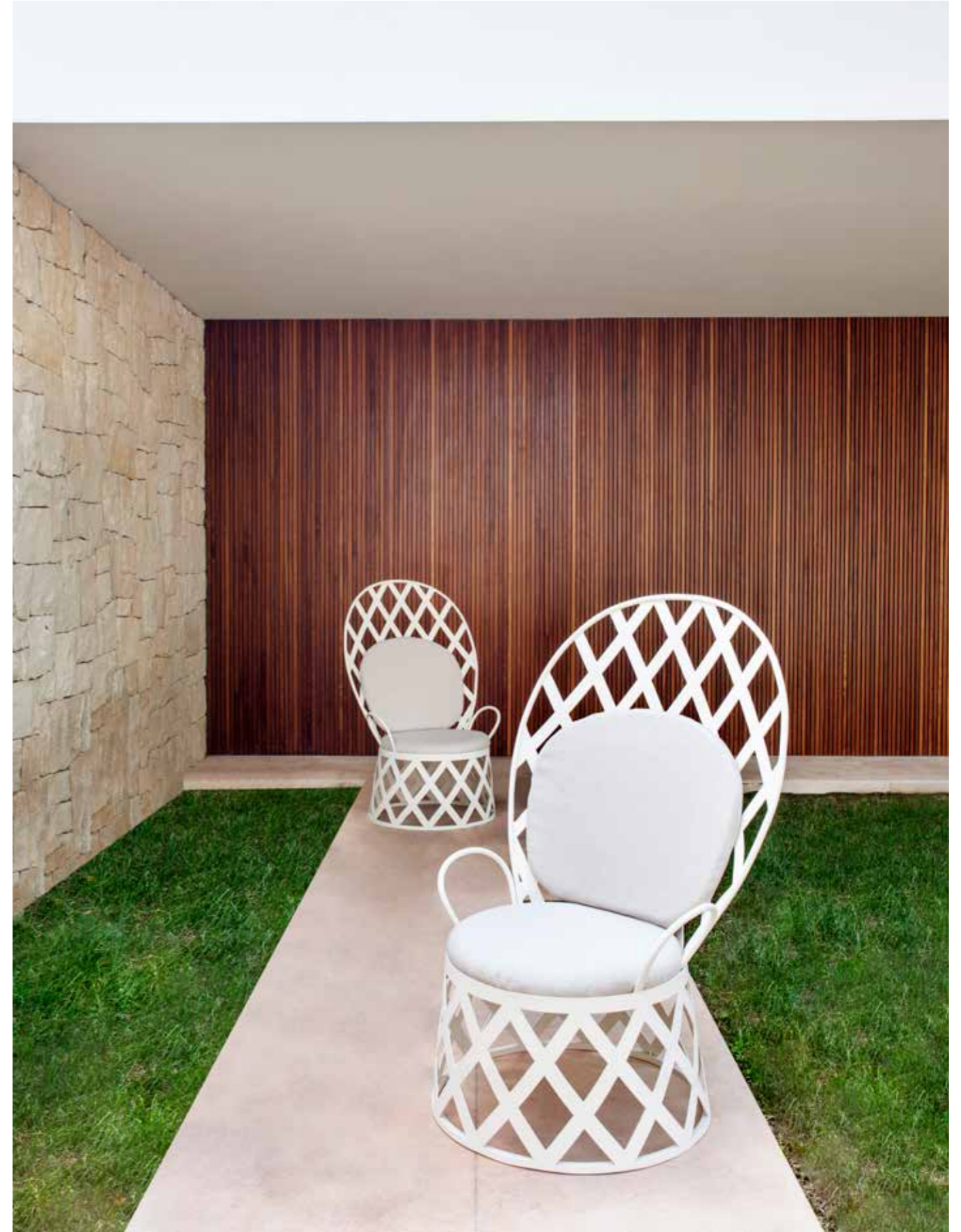



A White snow 70.
Blanco nieve 70.

B Blue sky 71.
Azul cielo 71.

C Green ficus 73.
Verde ficus 73.

D Gunmetal grey 56.
Gris metalizado 56.

E Cream 34.
Crema 34.

F Sand 74.
Arena 74.

G Terracotta 72.
Terracota 72.

H Oxide 75.
Óxido 75.

NEW
Sir

Francesc Rifé

Los muebles de aluminio de la colección Sir, con sus líneas rectas, sus respaldos en tela Batyline® y sus reposabrazos de madera natural de teca están diseñados para vivir las mejores experiencias *contract* y *hospitality*. Un glamour cálido y confortable para practicar el exteriorismo con estilo.

The aluminium furniture from the Sir collection, with its straight lines, its Batyline® fabric upholstery and its natural teak wood armrests, is designed to facilitate the best contract and hospitality experiences. Offering cosy and comfortable glamour to help create a stylish exterior design.





In page 45, armchair and ottoman in gunmetal grey 56.

On the current page, armchair and ottoman in cream 34.



On the current page,
armchair in cream 34.

On the next page, armchair and
ottoman in green ficus 73.





- A Cream 34.
Crema 34.
- B Oxide 75.
Óxido 75.
- C Sand 74.
Arena 74.
- D White snow 70.
Blanco nieve 70



- E Green ficus 73.
Verde ficus 73.
- F Terracotta 72.
Terracota 72.
- G Gunmetal grey 56.
Gris metalizado 56.
- H Blue sky 71.
Azul cielo 71.

NEW
T

Gabriel Teixidó

En el exterior caben todos los colores y la innovadora colección T nos los trae en forma de sintéticas butacas, taburetes, mesitas y puffs de aluminio con algunos elementos tapizados. Diseño depurado y funcionalidad para espacios *contract* y *hospitality* que escapan a lo convencional.

All colours can be used outdoors and the innovative T collection brings them to us in the form of synthetic armchairs, bar stools, small tables and aluminium ottomans with a few upholstered elements. Refined design and functionality for contract and hospitality spaces that go beyond the merely conventional.





On the previous page bar stool in terracotta 72.

On the current page, armchair, ottoman, table and bar stool in terracotta 72 and HPL table top in black.

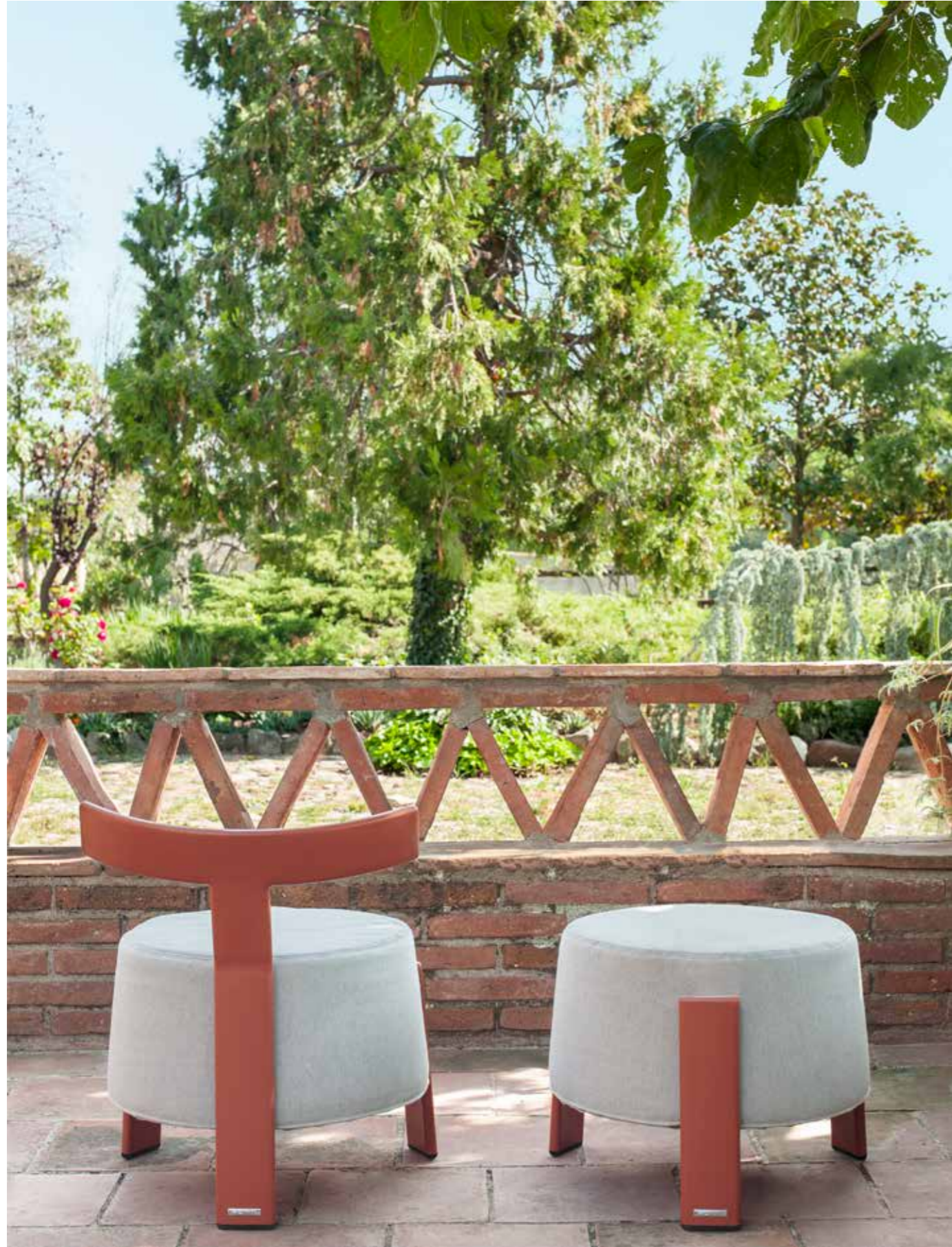

Armchair and ottoman
in terracotta 72.



A



B



C



D



E



F



G



H

- A Sand 74.
Arena 74.
- B White snow 70.
Blanco nieve 70.
- C Gunmetal grey 56.
Gris metalizado 56.
- D Cream 34.
Crema 34.

- E Green ficus 73.
Verde ficus 73.
- F Terracotta 72.
Terracota 72.
- G Oxide 75.
Óxido 75.
- H Blue sky 71.
Azul cielo 71.

Weave

German Design Award Nominee 2019.
 IIDA Global Excellence Awards, 2018.
 Medalla de Oro Bienal CIDI, 2017.
 ADCV. ORO, Mobiliario Exterior, 2017.

Vicent Martínez

Anudando fibra a fibra, minuciosamente, como los pájaros Baya Weaver forman sus nidos, nace esta colección que evoca la tradición de envolver, atrapar y anudar las estructuras de cuerda que dieron origen a la firma hace 100 años. Sentarse, reclinarse en un sillón, tumbarse, mecerse, todo es posible en los más de 15 muebles con un sinfín de posibilidades de composición para crear espacios relajantes en el exterior.

By meticulously weaving each fibre together, just as the Baya Weaver birds build their nests, this collection evokes the tradition of wrapping, grabbing and knotting the rope structures from which the company was born 100 years ago. Sitting or reclining in an armchair, lying down, rocking... everything is possible with the more than 15 pieces of furniture offering an endless number of variations when it comes to create relaxing, outdoor spaces.





In page 61, armchair and coffee table in finish 60 and HPL table top in black.

On the previous and the current page, armchair, sofa 3, coffee table and corner table in finish 60 and HPL table top in black.



Rounded sunbed, coffee table and corner table in finish 63 and HPL table top in beige.





On the previous page, swing with base in finish 61.

On the current page, swing in finish 61.



In this page, chair in finish 61.

On the next page, chair and dining armchair in finish 61, table base 4 legs in cream 34 and HPL table top in beige.





Club armchair and club sofa 2 in finish 60, coffee table base 4 legs in taupe 60 and HPL table top in black.



Bar stool in finish 61, high table base 4 legs in cream 34 and HPL table top in beige.





On the previous page, dining armchair in finish 61, table base 4 legs in cream 34 and HPL table top in beige.

On the current and the next page, sunbed and sunbed arm in finish 60.





Reclining armchair and ottoman in finish 61.

German Design Award Nominee 2019.
IIDA Global Excellence Awards, 2018.
Medalla de Oro Bienal CIDI, 2017.



Reclining armchair and ottoman in finish 60 and 61.



- A** Finish 61: cream structure - nougat rope.
Acabado 61: estructura crema - cuerda turrón.
- B** Finish 63: taupe structure - nougat rope.
Acabado 60: estructura taupe - cuerda turró.
- C** Finish 60: taupe structure - taupe rope.
Acabado 63: estructura taupe - cuerda taupe.

A B C D E F G H I J K



- | | | | |
|---|--|---|----------------------------|
| A | Gunmetal grey 56.
Gris metalizado 56. | G | Toasted 03.
Tostado 03. |
| B | Blue sky 71.
Azul cielo 71. | H | Cream 34.
Crema 34. |
| C | Terracotta 72.
Terracota 72. | I | Oxide 75.
Óxido 75. |
| D | Sand 74.
Arena 74. | J | Dark 59.
Dark 59. |
| E | Green ficus 73.
Verde ficus 73. | K | Taupe 60.
Taupe 60. |
| F | White snow 70.
Blanco nieve 70. | | |



- L Black HPL top.
Tapa compacto negra.



- M Beige HPL top.
Tapa compacto beige.



- N Beige HPL top.
Tapa compacto beige.

Pal

Francesc Rifé

Pal es pura naturaleza, el encanto cálido de la madera a pocos centímetros de la madre tierra. Un sistema modular realizado con tarimas de madera maciza de teca que ofrece un sinfín de posibilidades de composición de espacios para el relax en el exterior. Sofás y mesas en comunión con la naturaleza y tapicerías en una variedad de colores que incluye la serenidad del verde.

Pal is pure nature, the cosy charm of wood just a few centimetres away from Mother Earth. A modular system made with solid teak wood planks that offers endless possibilities when it comes to setting up outdoor relaxation spaces. Sofas and tables in harmony with nature, and upholstery in a variety of colours that includes the serenity of green.







In page 85, right single seat & back, double seat & back + right arm, teak top tables and PUL metal table.

On the previous page, single seat & back + right arm, double seat & back + single seat & back + right arm to left, teak top tables, round table 28, round table 42 and PUL metal table.

On the current page, double seat & back + right arm to left, double seat & back + right arm, double seat & back + single seat + left arm, right double seat & back, round table 28, round table 42, teak top tables and PUL metal table.



On the previous page, base + left single seat & back + double seat, right complete sofa 2 and teak top tables.

In the details of the current page: on the left, PUL metal table; and on the right, round table 28 and 42.



Double seat & back + single seat & back + right arm, right double seat & back + single seat, teak top tables, round table 28 and 42 and PUL metal table.

Hamp

Medalla Black Silver CIDI, 2015.
Medalla de Oro Bienal CIDI, 2015.

Francesc Rifé

Rústicos y elegantes, así son los muebles de la colección Hamp. Un claro ejemplo del estilo country chic que derrite por su encanto y refresca por sus materiales naturales. Madera de teca y tela Batyline® de alta calidad, ambas ecológicas y ultrarresistentes para que disfrutes del campo con todas las comodidades.

Rustic and elegant, that's the furniture in the Hamp collection. A clear example of the country chic style whose charm will leave its mark and will be a breath of fresh air thanks to the natural materials. High-quality teak wood and Batyline® fabric, both of which are organic and ultra-resistant, allowing you to enjoy the countryside with all of the comforts imaginable.



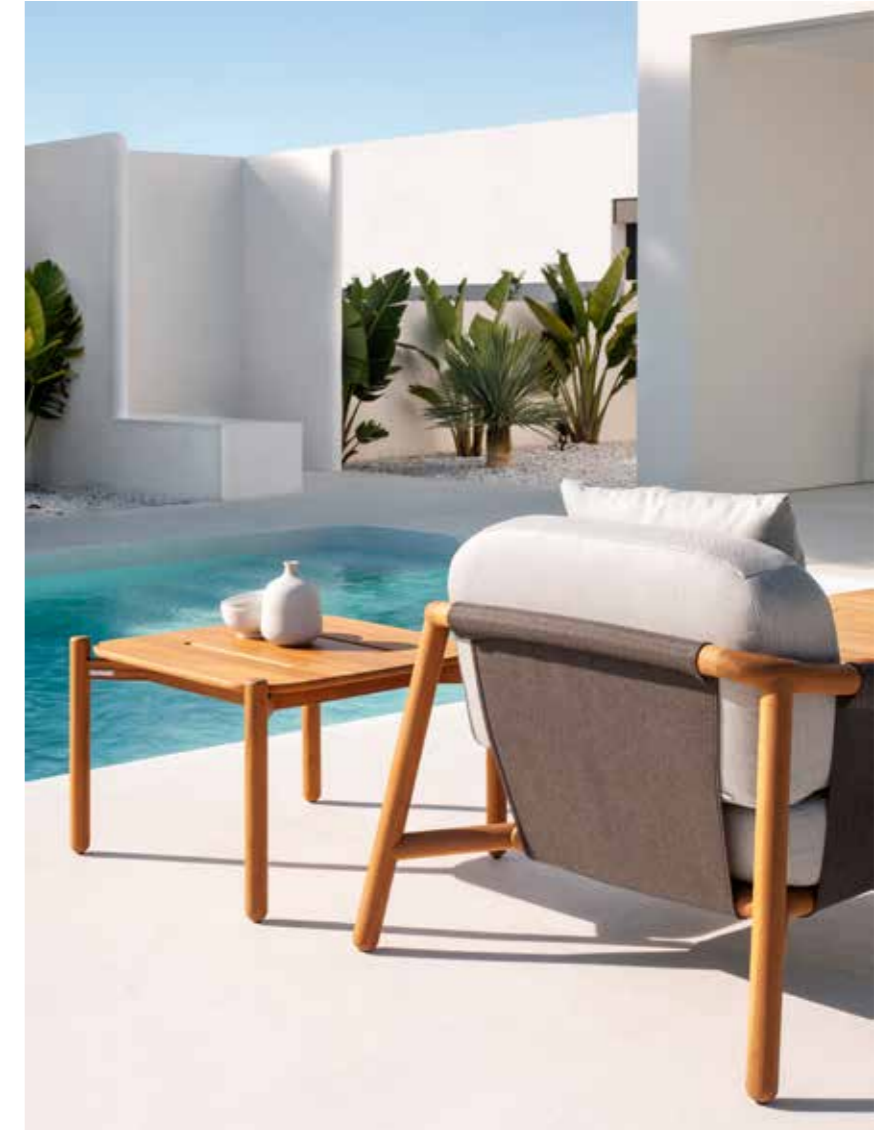

In page 95, dining armchair in batyline 09 and dining table in natural teak.

On the previous and the current page, lounge armchair and sofa 2 in batyline 10 and rectangular coffee table and corner table in natural teak.



Lounge armchair and sofa 2 in batyline 10 and rectangular coffee table and in natural teak.



Dining armchair in batyline 09 and dining table in natural teak.

Medalla Black Silver CIDI, 2015.



Lounge armchair in batyline 11 and corner table in natural teak.



- A **Batyline 13 fabric and natural teak structure.**
Tela batyline 13 y estructura de teca natural.
- B **Batyline 09 fabric and natural teak structure.**
Tela batyline 09 y estructura de teca natural.
- C **Batyline 10 fabric and natural teak structure.**
Tela batyline 10 y estructura de teca natural.
- D **Batyline 11 fabric and natural teak structure.**
Tela batyline 11 y estructura de teca natural.

Tub

Gabriel Teixidó

¿Quién dijo que las líneas rectas y las curvas no pueden combinarse? Unas aportan dinamismo y las otras dulcifican los contornos. Así de rotunda y atrevida es la colección Tub. Sillas, sillones, sofás y mesas de aluminio en un lenguaje limpio y contemporáneo perfecto para importarlo a las instalaciones más modernas.

Who said that straight lines and curves can't go together? Some add vitality while the others soften the contours. And this is exactly what makes the Tub collection so bold and daring. Chairs, armchairs, sofas and aluminium tables in a clean and contemporary language that is perfect for introducing into the most modern installations.





On the previous page, armchair and corner table in gunmetal grey 56 and table top in lava grey 82.

On the current page, armchair, sofa 3 and coffee table in cream 34, table top in natural white 81 and MIST planters in ivory 36.



On the previous page, dining armchair, chair and dining table in gunmetal grey 56 and table top in black 84.

On the current page, dining armchair in gunmetal grey 56.



Dining armchair and dining table in cream 34 and table top in natural white 81.



A White snow 70.
Blanco nieve 70.

B Sand 74.
Arena 74.

C Terracotta 72.
Terracota 72.

D Oxide 75.
Óxido 75.

E Green ficus 73.
Verde ficus 73.

F Cream 34.
Crema 34.

G Blue sky 71.
Azul cielo 71.

H Gunmetal grey 56.
Gris metalizado 56.



Lineal

Gabriel Teixidó

Las líneas rectas son el camino más corto al confort. Sencillas y puras, en la colección Lineal dan vida a unos muebles de exterior que se combinan y complementan entre sí. Asientos y mesas en teca natural y con cojines de tejidos frescos y resistentes de los que no querrás moverte. La suerte es que no tendrás que hacerlo porque hasta los reposabrazos están pensados para servir de mesita.

Straight lines are the shortest way to comfort. Simple and pure, in the Lineal collection these lines bring outdoor furniture to life, which can be mixed and matched. Seating pieces and tables in natural teak and with cushions made of fresh, resistant fabrics that'll make you never want to move. And it's your lucky day, because even the armrests are designed to be used as a table.

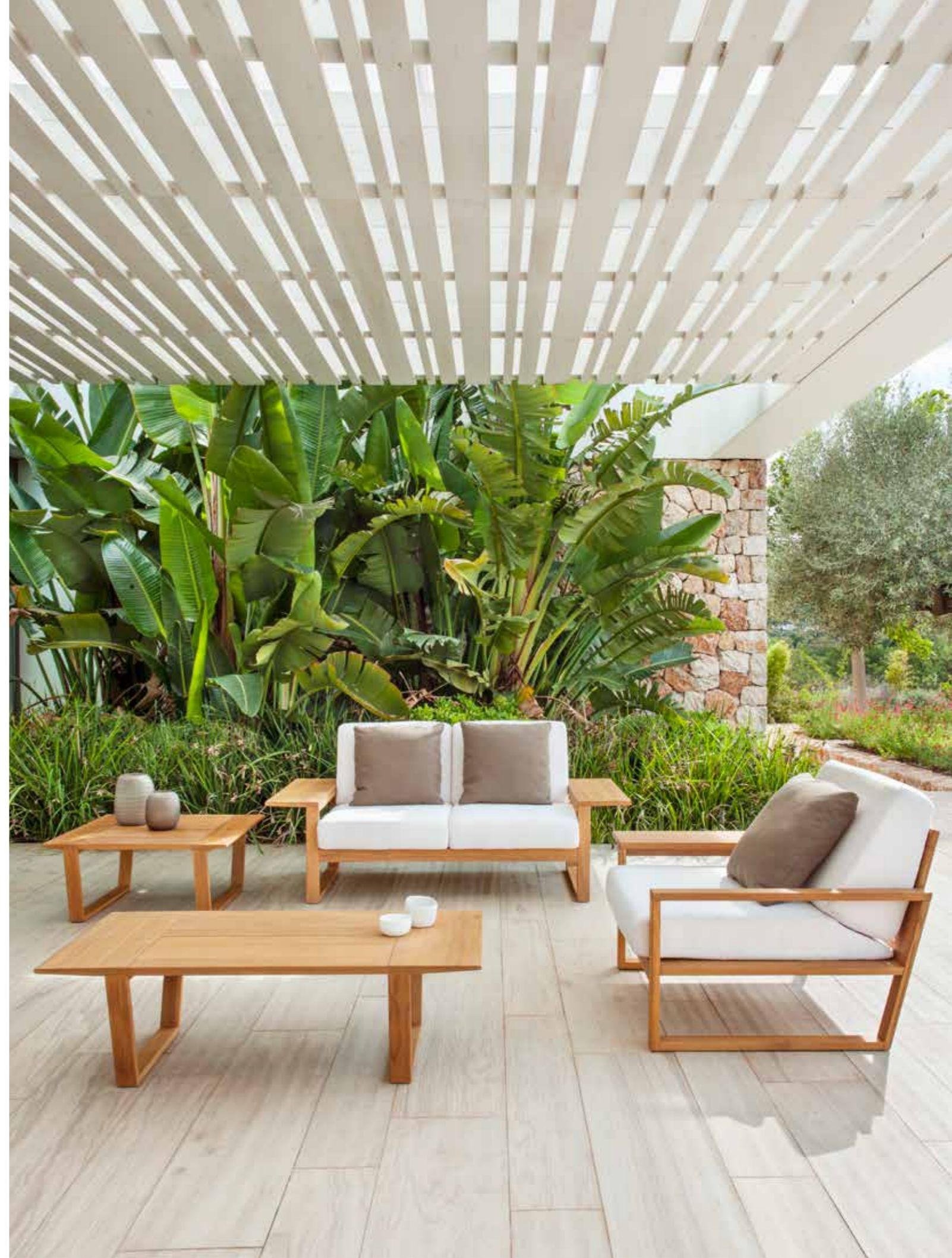



Sunbed and auxiliar table in natural teak.

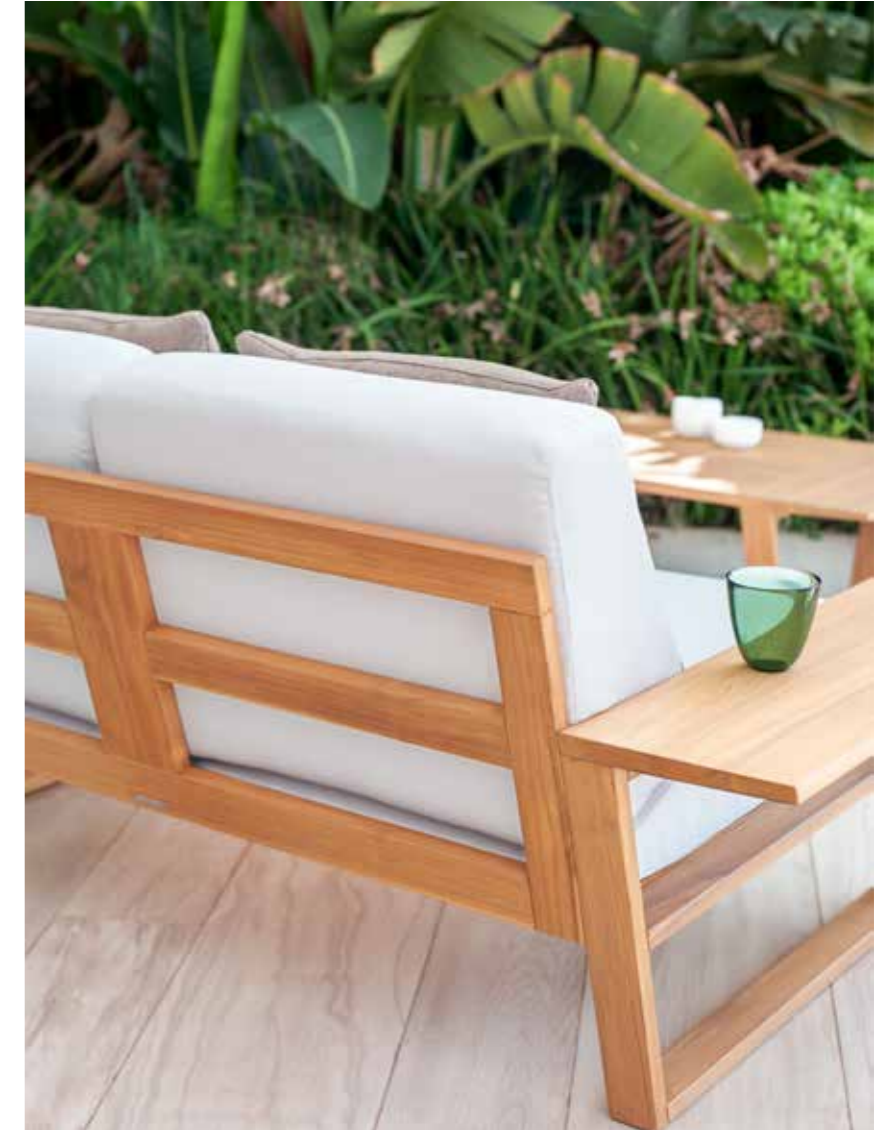

In page 117 and on the current page, armchair, sofa 2, corner table and rectangular coffee table in natural teak.

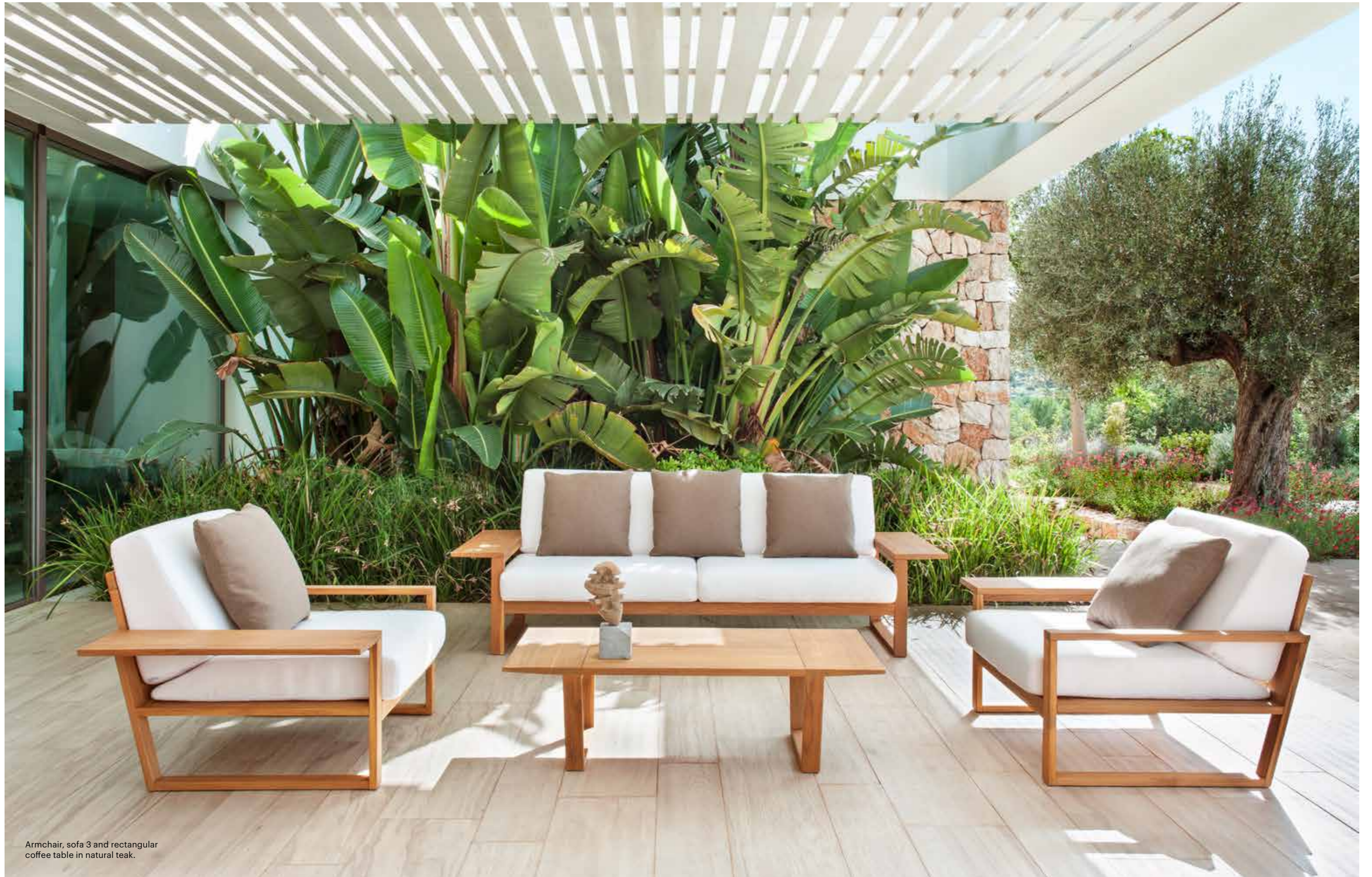

Armchair, sofa 3 and rectangular coffee table in natural teak.

Arc

Gabriel Teixidó

Blanco, negro y madera, la decoración más luminosa y serena, es infalible en cualquier instalación. La colección Arc combina la fibra sintética Shintotex®, trenzada a mano, con la madera de teca para crear unos muebles doblemente resistentes y muy modernos. Sofás, sillas, taburetes, sillones, mesas de comedor, de centro y rinconeras.

Black, white and wood, the brightest and most serene type of decoration, is infallible in any installation. The Arc collection combines Shintotex® handwoven synthetic fibre with teak wood to create incredibly modern furniture that is twice as strong. Sofas, chairs, stools, armchairs, dining tables, coffee tables and corner tables.





In page 123, dining armchair and dining table in white 35.

On the previous page, sofa 3, armchair, corner table and rectangular coffee table in white 35.

On the current page, sofa 2 in white 35.



Chair, dining armchair and dining table in dark 59.





On the previous page, bar stool in white 35.



On the current page bar stool in dark 59.



Club armchair, corner table
and bar stool in white 35.



A White flat 7 mm weaving and natural teak legs.
Trenzado blanco flat 7 mm y patas de teca natural.

B Dark flat oval 6 mm weaving and natural teak legs.
Trenzado dark flat oval 6 mm y patas de teca natural.

Jazz

Point Studio

Con respaldo reclinable, apilable y con ruedas para su fácil transporte. La línea Jazz de muebles en aluminio para terraza y jardín lo tiene todo para garantizar el descanso perfecto. Exteriorismo de calidad con un plus de confort.

With a reclining backrest, stackable, and with wheels for easy transport. The Jazz line of aluminium furniture for patios and gardens has everything you need to guarantee a perfect space for relaxation. Quality exterior design with extra comfort.





In page 135, sunbed and auxiliar table in grey 49, HPL table top in beige and BEACH umbrella in batyline 35.



On the previous and the current page, sunbed and auxiliar table in white snow 70, HPL table top in beige and OMBRA umbrella in fabric 21.

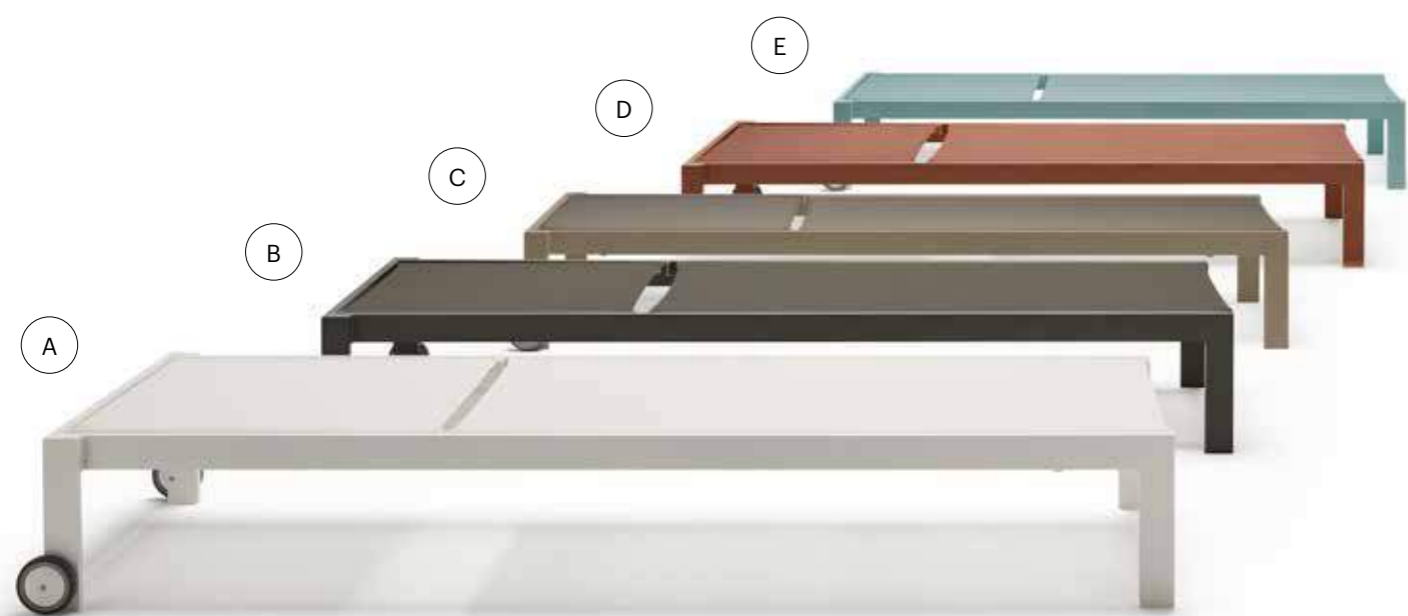

A White snow 70 with Batyline 35.
Blanco nieve 70 con Batyline 35.

B Oxide 75 with Batyline 38.
Óxido 75 con Batyline 38.

C Sand 74 with Batyline 37.
Arena 74 con Batyline 37.

D Terracotta 72 with Batyline 40.
Terracota 72 con Batyline 40.

E Blue sky 71 with Batyline 39.
Azul cielo 71 con Batyline 39.

F Green ficus 73.
Verde ficus 73.

G Cream 34.
Crema 34.

H Grey 49.
Gris 49.

I Gunmetal grey 56 with Batyline 57.
Gris metalizado 56 con Batyline 57.

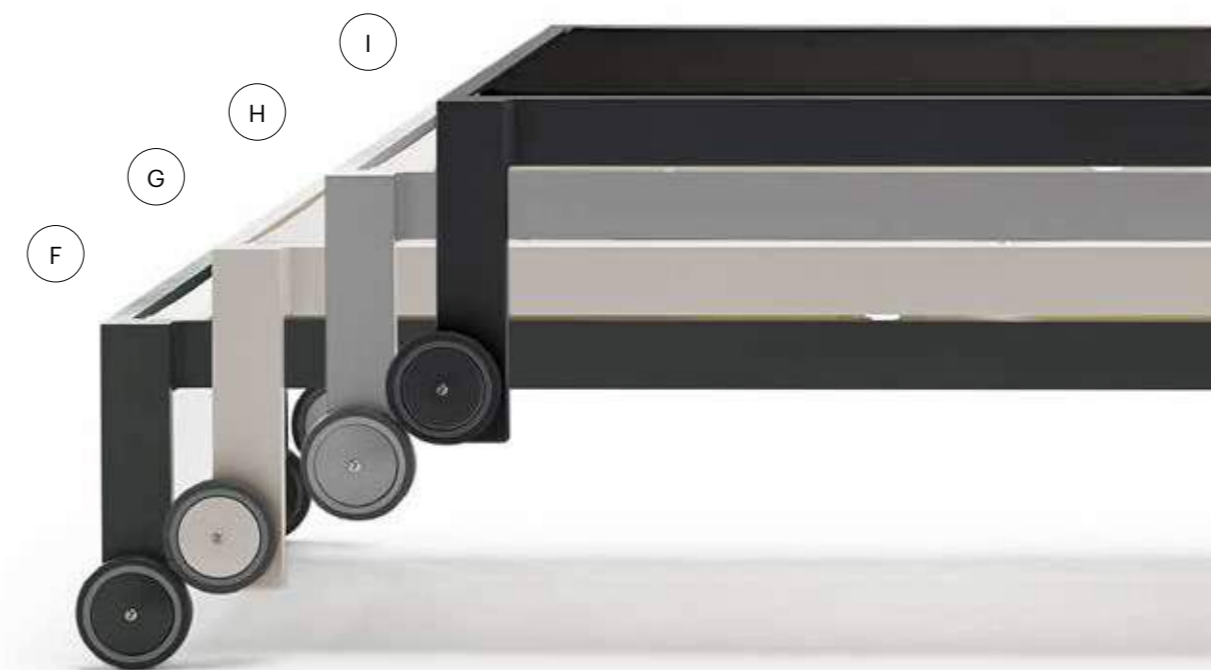

Fennec

Gabriel Teixidó

Hay asientos que tienen alas y, cuando nos sentamos en ellos, nuestro cuerpo vuela, ingrávido como una pompa de jabón. Así son los sillones Fennec con reposabrazos. Junto a ellos mesas en varios tamaños y tonos y con esa inteligente mezcla de diseño, confort y funcionalidad que requieren los exteriores más exigentes.

Some seats have wings and allow our bodies to fly, weightless like a feather. That's how you would describe the Fennec armchairs, with armrests and a headrest. But they're not alone. The tables come in various sizes and tones with an intelligent mix of design, comfort and functionality that is required by the most demanding outdoor spaces.





In page 141, dining armchair and dining table in dark 59 and table top in lava grey 82.

On the previous and the current page, dining armchair and dining table in ivory 36 and table top in natural white 81.

On the next page, dining armchair and dining table in ivory 36 and table top in natural white 81.





A Flat oval 6mm weaving in ivory 36.
Trenzado flat oval 6mm en marfil 36.

B Flat oval 6mm weaving in dark 59.
Trenzado flat oval 6mm en dark 59.

Round

Francesc Rifé

Hay muebles que estrechan lazos. Sinuosas y orgánicas, las formas circulares y ovaladas de la colección Round son un plan redondo para tus exteriores. Ideales tanto para el hogar y el sector de la hostelería, junto a la teca natural incorporan una innovadora gama de colores en la fibra sintética Shintotex®.

There is some furniture that strengthens connections. Sinuous and organic, the circular and oval shapes of the Round collection are truly a well-rounded plan for your outdoor spaces. Ideal for both homes and the hospitality industry, they incorporate natural teak along with an innovative range of colours in the Shintotex® synthetic fibre.







In page 149, sofa 2 in ivory 36, auxiliar table in natural teak and table top in natural white 81.

In page 150-151, armchair and sofa 3 in ivory 36, coffee table in natural teak and table top in natural white 81.

On the current page, chair in multicolor 10 and dining table in natural teak and table top in black 84.



On the current and the next page,
bar stool in multicolor 10.

In page 156-157, chair in ivory 36,
dining table in natural teak and
table top in natural white 81.







A Round Ø 3 mm weaving in multicolor 10 and natural teak structure.
Trenzado round Ø 3 mm en multicolor 10 y estructura de teca natural.

B Round Ø 3 mm weaving in ivory 36 and natural teak structure.
Trenzado round Ø 3 mm en marfil 36 y estructura de teca natural.

Weekend

Juan Santos

Weekend, un oasis de frescura. Sus piezas cubren todas las posibilidades de relax al aire libre. Modelos actuales que destacan por sus líneas desenfadadas, su confort y la gran solidez de sus materiales. Para crear ambientes confortables con un sentido absoluto de la funcionalidad.

The Weekend collection is an oasis of freshness. Its pieces offer everything you need in terms of outdoor relaxation. These new models stand out thanks to their carefree lines, comfort and the remarkable strength of their materials. Creating comfortable environments with an absolute sense of functionality.





On the previous page
armchair in white snow 70
and batyline 35, dining table
in white snow 70 and table
top in grey 92.

On the current page chair and
armchair in white snow 70 and
batyline 35, extendable table in
white snow 70 and table top in
grey 92.



Armchair in white snow
70 and batyline 35.

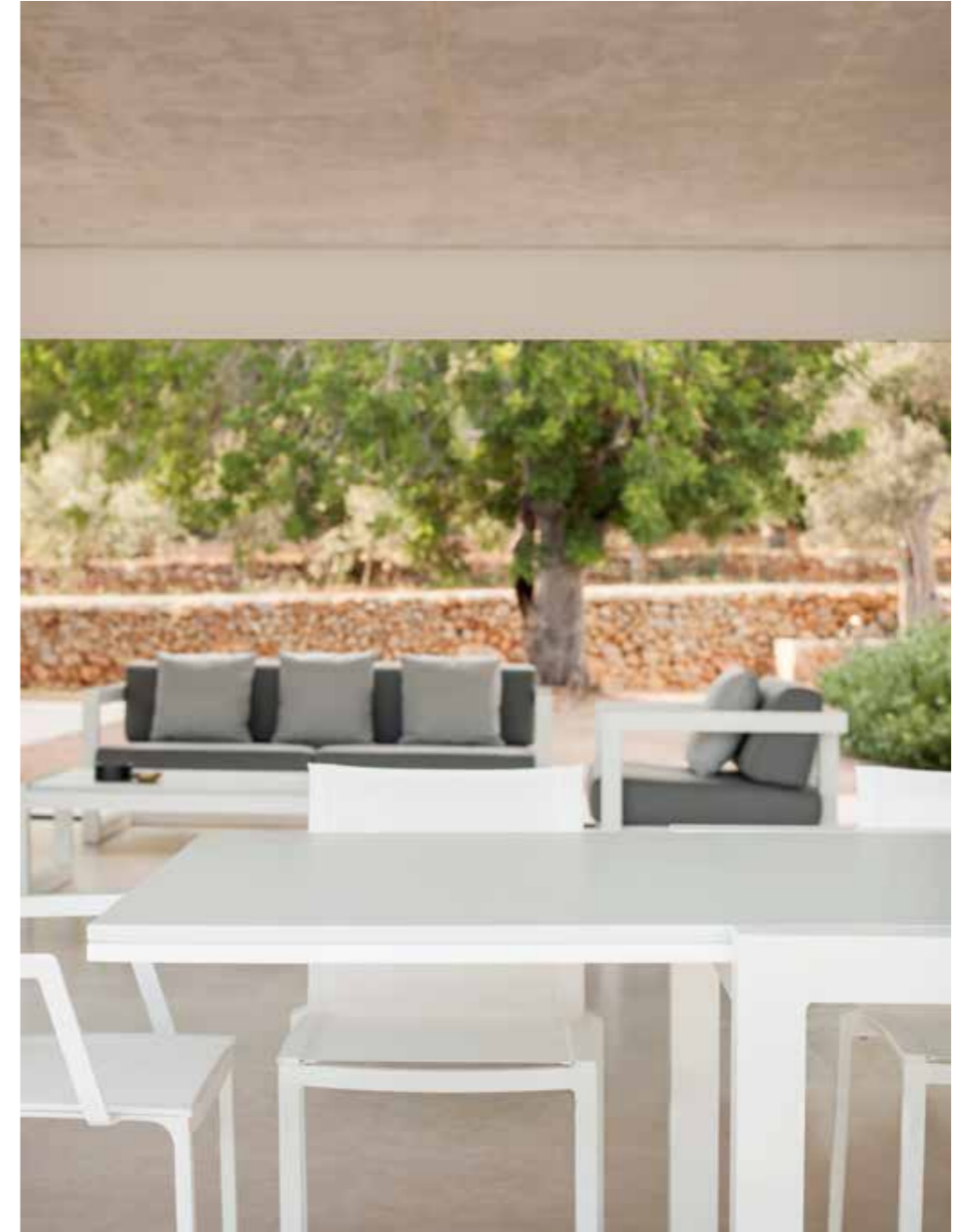

Chair and armchair in white snow
70 and batyline 35, extendable
table in white snow 70 and table
top in grey 92.



Armchair, sofa 3, coffee table and corner table in white snow 70 and table top in grey 92.



Armchair and ottoman
in white snow 70.





WEEKEND sunbed in white snow 70 and batyline 35, auxiliar table in white snow 70, table top in grey 92 and BEACH umbrella in batyline 35.



A Terracotta 72 with Batyline 40.
Terracota 72 con Batyline 40.

B Green ficus 73 with Batyline 37.
Verde ficus 73 on Batyline 37.

C Sand 74 with Batyline 37.
Arena 74 con Batyline 37.

D White snow 70 with Batyline 35.
Blanco nieve 70 con Batyline 35.

E Cream 34 with Batyline 35.
Crema 34 con Batyline 35.

F Oxide 75 with Batyline 38.
Óxido 75 con Batyline 38.

G Blue sky 71 with Batyline 39.
Azul cielo 71 con Batyline 39.

H Gunmetal grey 56 with Batyline 57.
Gris metalizado 56 con Batyline 57.

A



B



C



D



A Polyethylene black 93.
Polietileno negro 93.

B Polyethylene white 90.
Polietileno blanco 90.

C Polyethylene taupe 91.
Polietileno taupe 91.

D Polyethylene grey 92.
Polietileno gris 92.

U

Gabriel Teixidó

Una idea intuitiva, crear una silla apilable, de la que surgió U, una de las series más exitosas de POINT. Hasta 17 piezas, tres tonos y todas las funcionalidades de los muebles POINT elaborados en su fibra sintética Shintotex®, trenzada a mano. Un *must have* adaptable a cualquier espacio exterior en hogares, hoteles o restaurantes para crear exteriores con estilo.

The U is one of POINT's most successful series, arising from the intuitive idea of creating a stackable chair. Up to 17 pieces, three tones, all the characteristics of POINT furniture, and made in their handwoven synthetic Shintotex® fibre. A *must-have* series that can be adapted to any outdoor space in homes, hotels or restaurants to create outdoor spaces with style.





In page 177, dining armchair and rectangular dining table in toasted 03.

On the previous page, chair and square dining table in ivory 36.

On the current page, club armchair in toasted 03.



Dining armchair and square dining table in dark 59.





Sofa 2, sofa 3, club
armchair, club table and
coffee table in dark 59.



On the current page, chair in dark 59, toasted 03 and ivory 36.

On the next page, armchair and ottoman in toasted 03.





Bar stool and high table in toasted 03.



On the current page, high back armchair and club table in ivory 36.

On the next page, high back armchair, sofa 3, armchair and coffee table in ivory 36.





On the previous page, U sunbed in ivory 36 and ROMA umbrella in batyline 35.

In the current page, sunbed and auxiliar table in toasted O3.



A Flat oval 6mm weaving in dark 59.
Trenzado flat oval 6mm en dark 59.

B Flat oval 6mm weaving in toasted 03.
Trenzado flat oval 6mm en tostado 03.

C Flat oval 6mm weaving in ivory 36.
Trenzado flat oval 6mm en marfil 36.

Sunset

Esther Campos

Con cortina, para una siesta sin prisa, o sin ella, para un atardecer romántico... Sunset es una tumbona para compartir. Su ligero dosel, más allá de dar sombra, nos hace sentir como los protagonistas de un cuento contemporáneo. Su estructura, firme y resistente, es de aluminio anodizado, y el lecho es de la fibra sintética Shintotex® de POINT con su trenzado artesanal.

With a canopy for an unhurried nap, or without it for a romantic sunset... Sunset is a sun lounger to share. Its lightweight canopy, in addition to simply providing shade, makes us feel like the main characters in a modern-day fairytale. Its firm and resistant structure is made of anodised aluminium, while the bed is made of POINT's synthetic Shintotex® fibre with its handmade weaving.



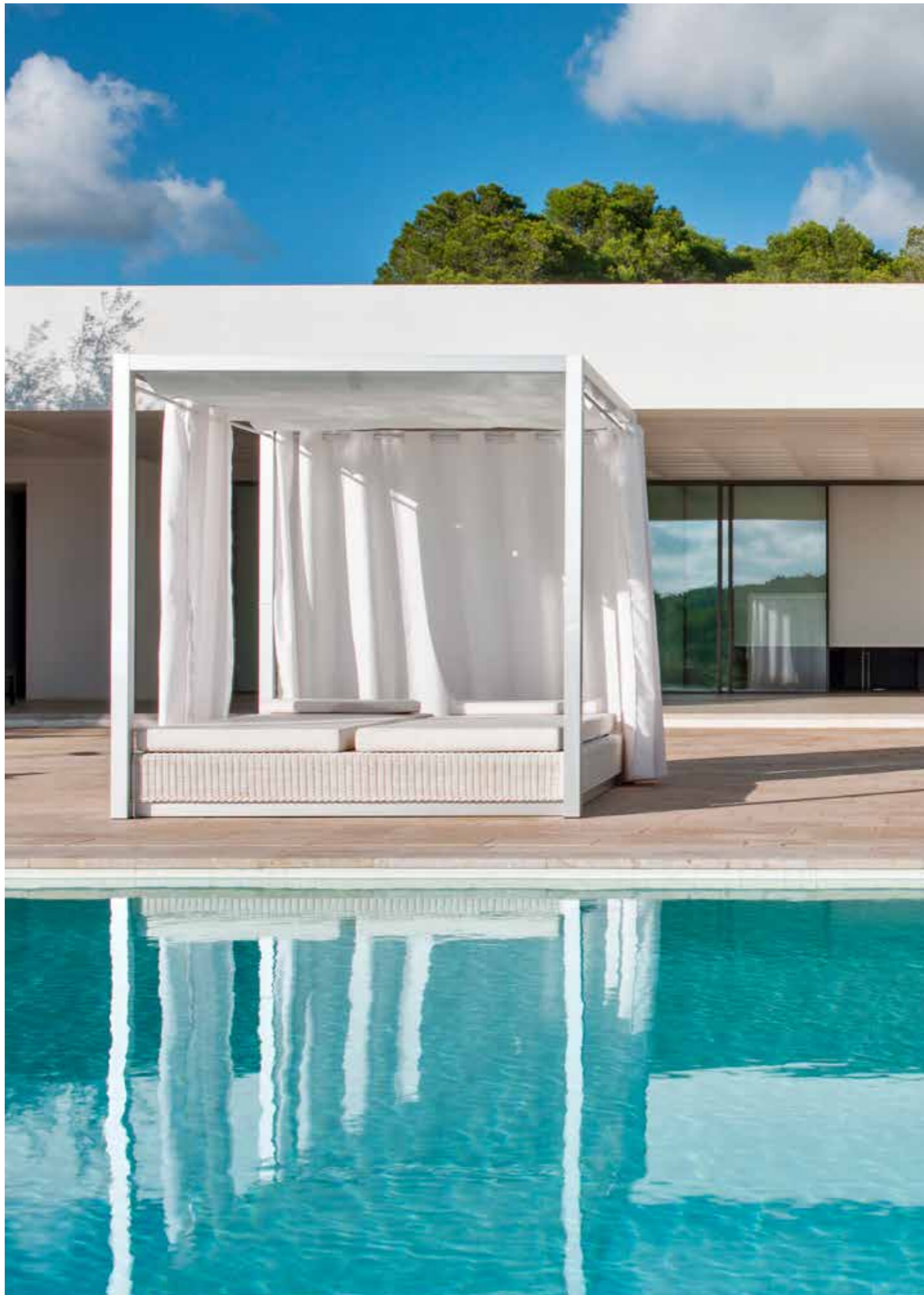

In page 195 double sunbed with no curtains in toasted 03.

On the previous and the current page, double sunbed with curtains in ivory 36.

Armadillo

Joaquín Homs

En el jardín como reyes. Es tiempo de elegir ese asiento que nos arropará en una lectura mágica, una siesta sin prisas o un baño de sol. Regresa por un momento a la infancia y déjate mecer por este columpio ligero y ultrafresco gracias a sus materiales naturales y resistentes. Detalles plus que elevan el tono del patio, terraza o jardín y asombran aportando su diferencia.

Imagine sitting in the garden like kings. Now's the time to pick that chair that will wrap us up as we read, take a carefree nap or sunbathe. Let yourself travel back in time for just a moment to your childhood, as you're rocked by this lightweight and incredibly fresh swing that features natural yet durable materials. Unique details that raise the bar when it comes to the atmosphere of your patio, terrace or garden, and which will leave you speechless once you've seen what a difference they make.





In page 199, swing in ivory 36.

On the previous and the current page, swing with base in toasted 03.

Colors & Compact

Gabriel Teixidó

Cuadradas, rectangulares o redondas, las tapas Compact con los pies Colors se unen para ofrecer infinitas combinaciones de mesas para espacios e instalaciones al aire libre. Líneas limpias, puras y sencillas en aluminio pintado, sin cristal y con patas disponibles en una gran variedad de colores.

Square, rectangular or round, the Compact tops with the Colors legs offer endless tables possibilities for outdoor spaces and installations. Clean, pure and simple lines in painted aluminium, without glass and with legs available in a wide range of colours.





In page 203 COLORS table base in dark 59, COMPACT HPL rounded top in black and TUB armchair in gunmetal grey 56.

On the previous page, COLORS table base in cream 34, COMPACT HPL square top in beige and WEEKEND armchair in white snow 70 and batyline 35.

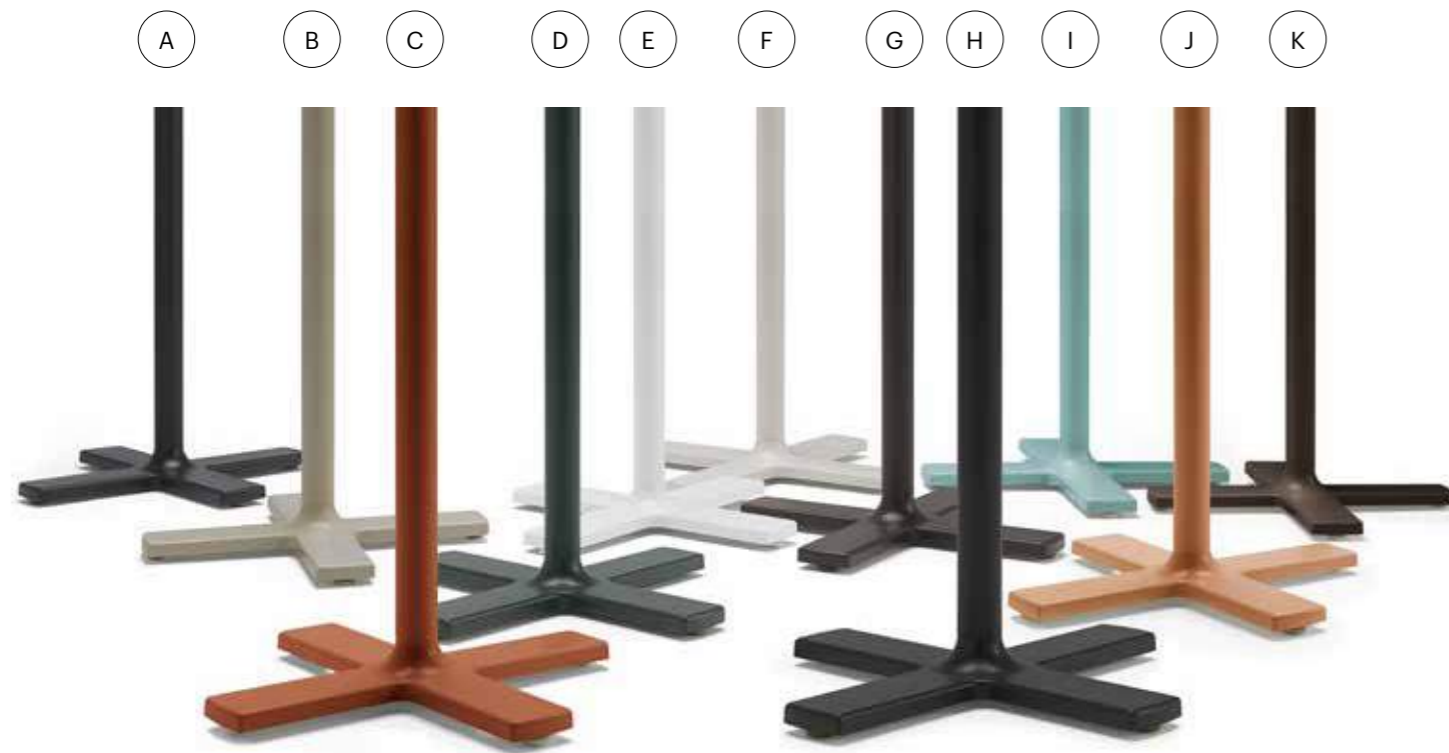

- | | | | |
|---|--|---|--------------------------------|
| A | Gunmetal grey 56.
Gris metalizado 56. | G | Oxide 75.
Óxido 75. |
| B | Sand 74.
Arena 74. | H | Dark 59.
Dark 59. |
| C | Terracotta 72.
Terracota 72. | I | Blue sky 71.
Azul cielo 71. |
| D | Green ficus 73.
Verde ficus 73. | J | Toasted 03.
Tostado 03. |
| E | White snow 70.
Blanco nieve 70. | K | Taupe 60.
Taupe 60. |
| F | Cream 34.
Crema 34. | | |



- | | |
|---|--|
| L | Black HPL top.
Tapa compacto negra. |
| M | Beige HPL top.
Tapa compacto beige. |

Mist

Estudi{H}ac

¿Y qué serían las noches al exterior sin un halo de misterio...? El curioso volumen del trenzado de fibra sobre la estructura de metal de las lámparas-jardineras Mist embellece tanto las plantas como la luz LED que incorporan. Un haz luminoso que se cuela por sus formas caladas y proyecta un efecto mágico creando atmósferas sofisticadas.

What would evenings outdoors be like without an air of mystery...? The interesting volume of the woven fibre on the metal structure of the Mist lamps/planters embellishes both the plants and the LED light that sneaks its way in and creates a magical effect that gives way to a sophisticated atmosphere.



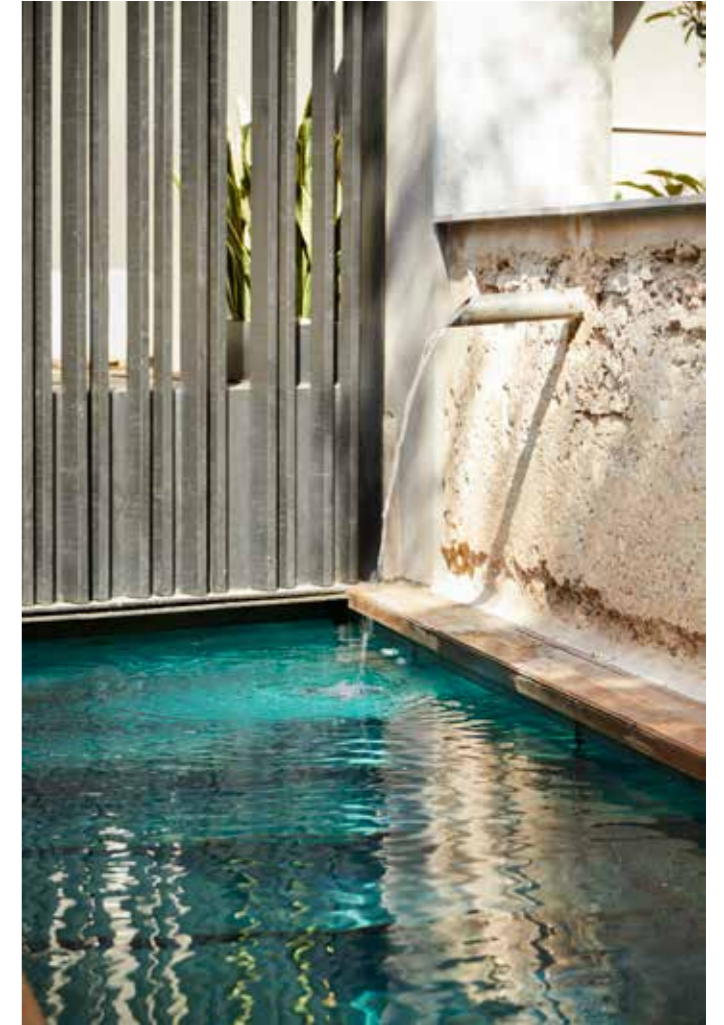

In page 209 lamp 150, lamp 110
and lamp 65 in dark 59.

On the previous page, planter 150,
planter 110 and planter 65 in ivory 36.

Umbrellas

Beach, Ombra & Roma

Point Studio

Diseño y funcionalidad se unen en la familia de parasoles de POINT. Tejidos de calidad en una amplia gama de tonalidades; y otros materiales como: aluminio, varillas de fibra de vidrio, baldosas de cerámica, de hormigón o de pvc con ruedas. Líneas depuradas y materiales *high tech* para resguardarse del sol en jardines, terrazas e instalaciones.

Form and function come together in the family of POINT umbrellas. Quality fabrics in a wide range of shades; and other materials such as: aluminium, fibreglass rods, ceramic tiles, concrete or PVC with wheels. Refined lines and high-tech materials to protect you from the sun in gardens, patios and other installations.





In page 213, OMBRA umbrella and base in fabric 21, and JAZZ sunbed in white snow 70.

In the current page, ROMA umbrella in batyline 35 and U sunbed in ivory 36.



BEACH umbrella in batyline 35,
WEEKEND sunbed in white snow
70, auxiliar table in white snow 70
and table top in grey 92.

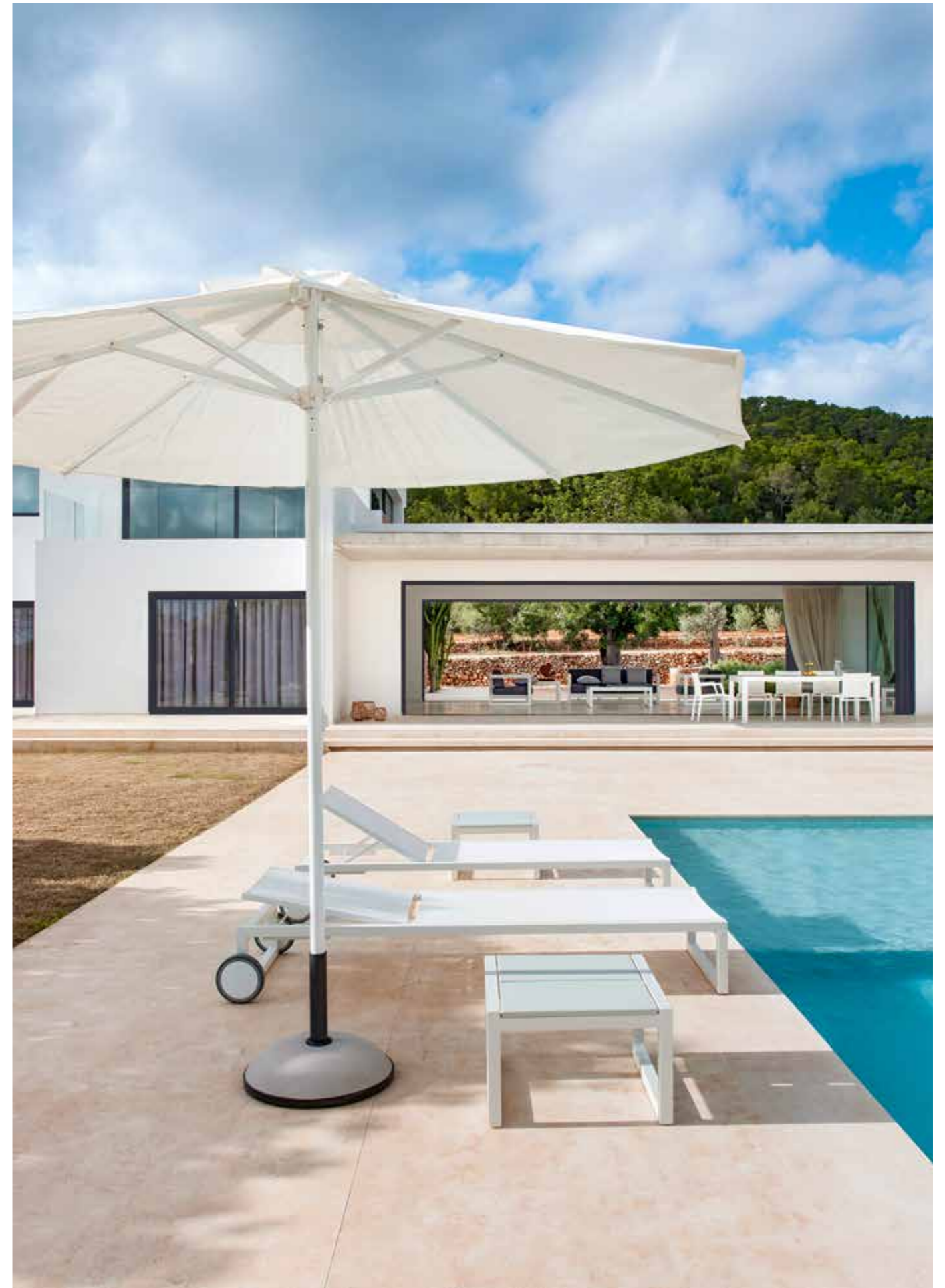

Technical
details

Arc

 Gabriel Teixidó

p. 122

Silla Chair

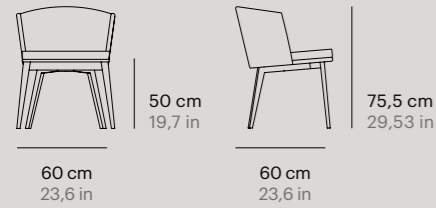

Ref. 76201

Peso Weight 10 Kg 22 lb (1pc)
19 Kg 41 lb (2pcs)
m³ 0,39 m³ (1pc) - 0,64 m³ (2pcs)

Sillón comedor Dining armchair

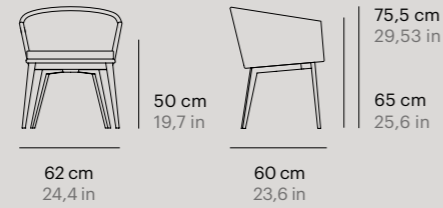

Ref. 76206

Peso Weight 10.5 Kg 23 lb (1pc)
m³ 0,42 m³

Taburete Bar stool

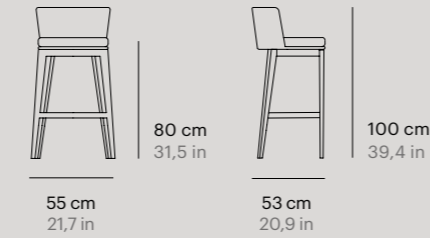

Ref. 76252

Peso Weight 9,9 Kg 21 lb
m³ 0,42 m³

Materiales Materials

Estructura Frame
Aluminio lacado Lacquered aluminum
Trenzado Weaving
Flat oval 6 mm - Flat 7 mm
Patas Legs
Teca Natural Natural Teak

Acabados trenzado Weaving finishes

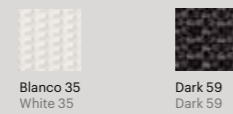

Acabados patas Legs finishes

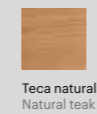

Sillón Armchair

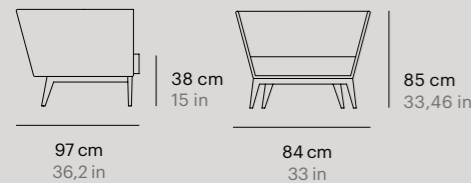

Ref. 76245

Peso Weight 26 Kg 57 lb (1pc)
m³ 0,68 m³
Cuadrantes Scatter cushions 1 (70x60) - 1 (50x50)

Sofá 2 Sofa 2

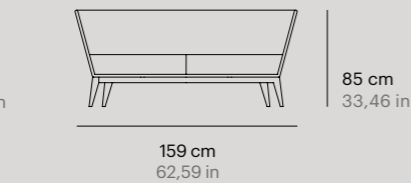

Ref. 76247

Peso Weight 39,5 Kg 87 lb
m³ 1,29 m³
Cuadrantes Scatter cushions 2 (70x60) - 2 (50x50)

Sofá 3 Sofa 3

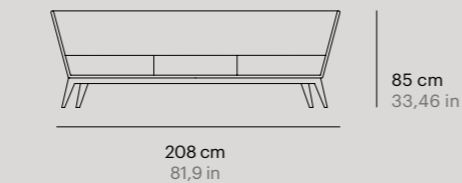

Ref. 76249

Peso Weight 52 Kg 114 lb
m³ 1,48 m³
Cuadrantes Scatter cushions 3 (70x60) - 3 (50x50)

Materiales Materials

Estructura Frame
Aluminio lacado Lacquered aluminum
Trenzado Weaving
Flat 7 mm
Patas Legs
Teca Natural Natural Teak

Acabados trenzado Weaving finishes

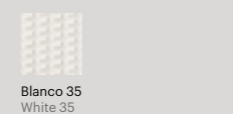

Acabados patas Legs finishes

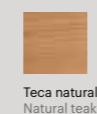

Arc

 Gabriel Teixidó

p. 122

Sillón club Club armchair

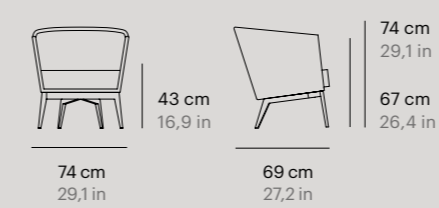

Ref. 76207

Peso Weight 13 Kg 28 lb
m³ 0,52 m³

Mesa rincón Corner table



Ref. 76256

Peso Weight 11 Kg s. cristal 24 lb no glass
14,4 Kg c. cristal 31 lb w. glass
m³ 0,31 m³ s.cristal no glass
1,29 m³ c. cristal w. glass

Mesa centro rectangular Rectangular coffee table

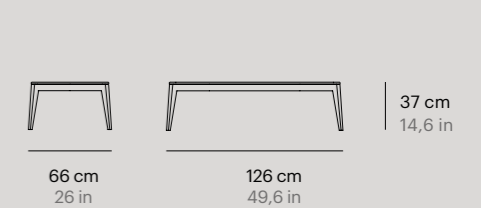

Ref. 76254

Peso Weight 20 Kg s. cristal 59 lb no glass
26,8 Kg c. cristal 124 lb w. glass
m³ 0,39 m³ s.cristal no glass
0,45 m³ c.cristal w. glass

Materiales Materials

Estructura Frame
Aluminio lacado Lacquered aluminum
Trenzado Weaving
Flat 7 mm
Patas Legs
Teca Natural Natural Teak

Acabados trenzado Weaving finishes

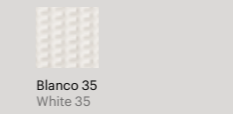

Acabados patas Legs finishes

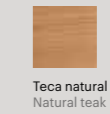

Mesa comedor Dining table

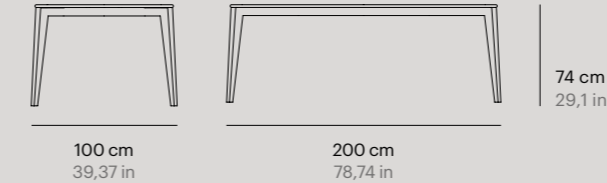

Ref. 76209

Peso Weight 42 Kg s. cristal 92 lb no glass
72 Kg c. cristal 158 lb w. glass
m³ 2,05 m³ s.cristal no glass
2,15 m³ c.cristal w. glass

Mesa comedor Dining table



Ref. 76210

Peso Weight 27 Kg s. cristal 59 lb no glass
56,4 Kg c. cristal 124 lb w. glass
m³ 2,02 m³ s.cristal no glass
2,12 m³ c.cristal w. glass

Materiales Materials

Estructura Frame
Aluminio lacado Lacquered aluminum
Trenzado Weaving
Flat oval 6 mm - Flat 7 mm
Patas Legs
Teca Natural Natural Teak

Acabados trenzado Weaving finishes

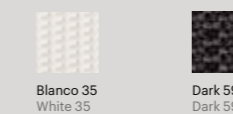

Acabados patas Legs finishes

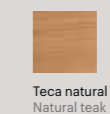

Armadillo

Joaquín Homs

p. 198

Columpio Swing

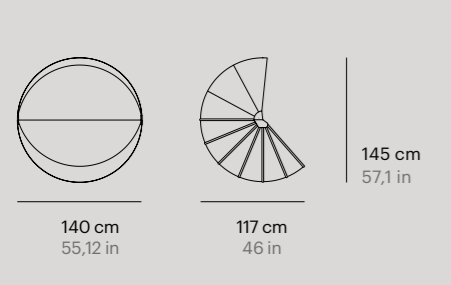

Ref. 76945

Peso Weight 29 Kg 64 lb
 m³ 1,37 m³
 Cuadrantes Scatter cushions 4 (50x50) - 3 (40x40)

Columpio con base Swing with base

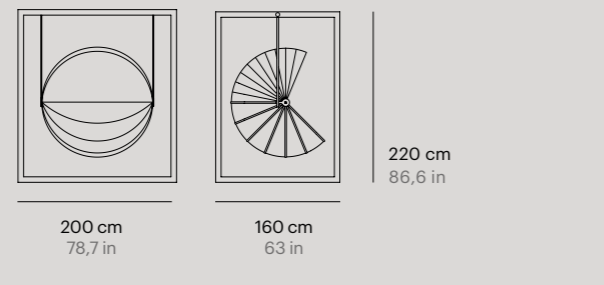

Ref. 76946

Peso Weight 100 Kg 220 lb
 m³ 1,6 m³
 Cuadrantes Scatter cushions 4 (50x50) - 3 (40x40)

Materiales Materials

Estructura Frame
 Aluminio anodizado Anodized aluminium
 Trenzado Weaving
 Round Ø 3 mm

Acabados trenzado Weaving finishes

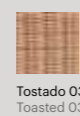
Marfil 36
Ivory 36Tostado 03
Toasted 03

Acabado estructura Frame finishes

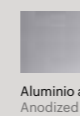
Aluminio anodizado
Anodized aluminium

Colors

Gabriel Teixidó

p. 202

Pie de mesa Table base

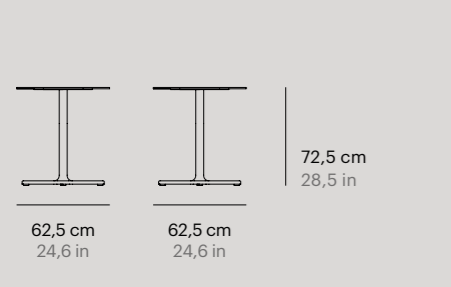

Ref. 74214

Peso Weight 13,5 Kg 29 lb
 m³ 0,37 m³

Pie de mesa doble Double table base

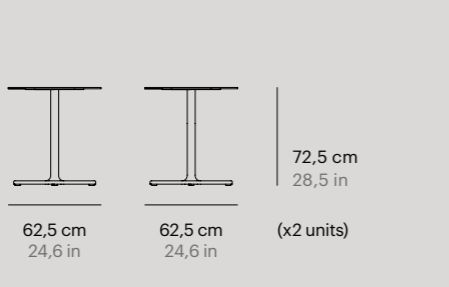

Ref. 74208

Peso Weight 27 Kg 50 lb
 m³ 0,74 m³

Materiales Materials

Estructura Frame
 Aluminio pintado en polvo
 Powder coated aluminium

Acabados Finishes



Compact

p. 202

Tapa compacto HPL top

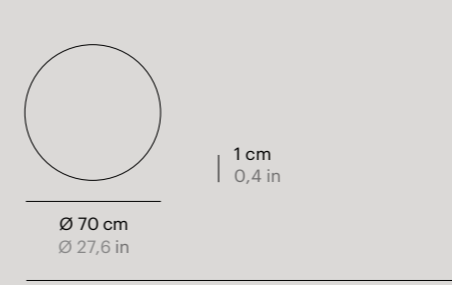

Ref. 74314

Peso Weight 8 Kg 17 lb
 m³ 0,04 m³

Tapa compacto HPL top

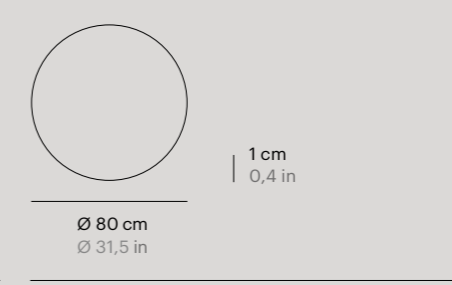

Ref. 74309

Peso Weight 10 Kg 22 lb
 m³ 0,05 m³

Tapa compacto HPL top

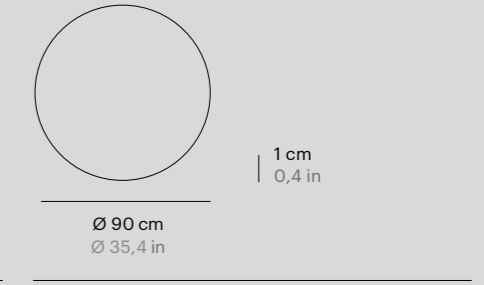

Ref. 74307

Peso Weight 12 Kg 26 lb
 m³ 0,06 m³

Tapa compacto HPL top

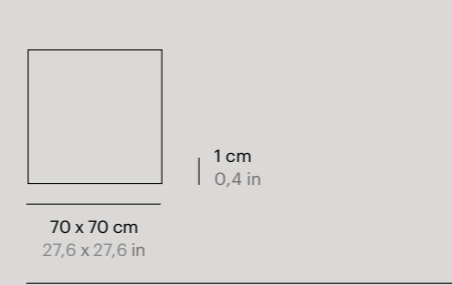

Ref. 74315

Peso Weight 10 Kg 22 lb
 m³ 0,04 m³

Tapa compacto HPL top

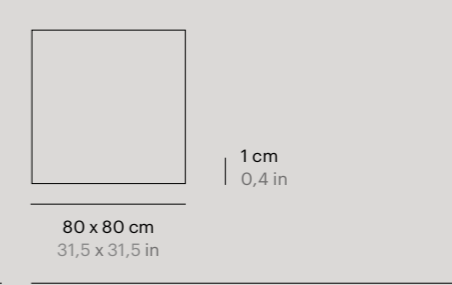

Ref. 74310

Peso Weight 11,5 Kg 25 lb
 m³ 0,05 m³

Tapa compacto HPL top

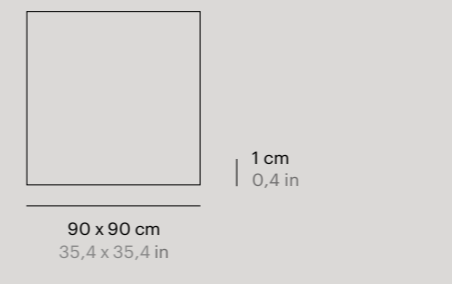

Ref. 74311

Peso Weight 13 Kg 28 lb
 m³ 0,06 m³

Tapa compacto HPL top

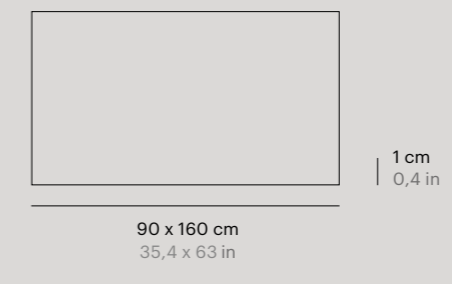

Ref. 74308

Peso Weight 22,5 Kg 49 lb
 m³ 0,11 m³

Materiales Materials

Tapa Top
 Compacto
 HPL

Acabados Finishes

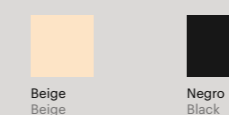

Dalmatia

Nika Zupanc

p. 30

Silla Chair

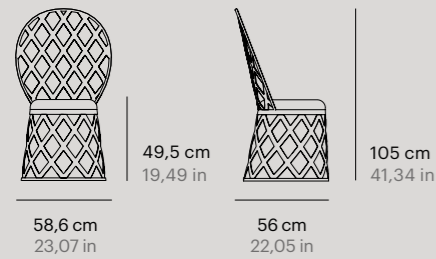

Ref. 77501

Peso Weight 10,4 Kg 22,9 lb
m³ 0,45 m³

Sillón XL Armchair XL

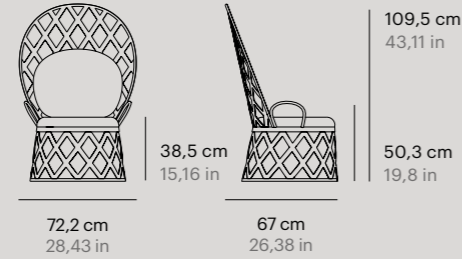

Ref. 77507

Peso Weight 12,6 Kg 27,9 lb
m³ 0,67 m³

Sillón Armchair

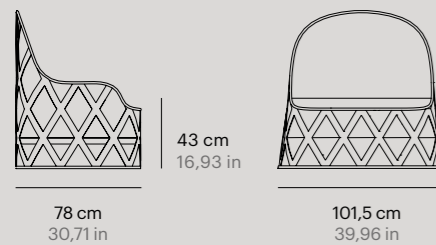

Ref. 77545

Peso Weight 24,4 Kg 53,8 lb
m³ 0,91 m³

Sofá 2 Sofa 2

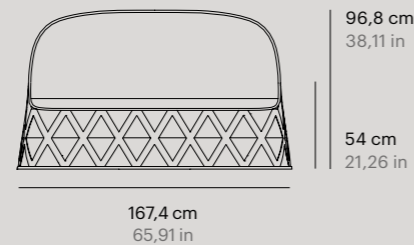

Ref. 77547

Peso Weight 38,6 Kg 85,1 lb
m³ 1,46 m³

Materiales Materials

Estructura Frame
Aluminio pintado en polvo
Powder coated aluminum

Acabados Finishes



Dalmatia

Nika Zupanc

p. 30

Mesa comedor redonda Round dining table



Ref. 77510

Peso Weight 52,5 Kg 115,7 lb
m³ 0,4 m³

Mesa comedor ovalada Oval dining table

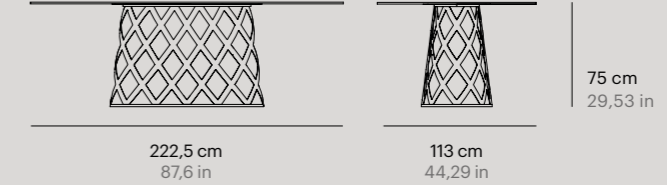

Ref. 77509

Peso Weight 82,6 Kg 182,2 lb
m³ 0,74 m³

Mesa centro redonda Round coffee table



Ref. 77553

Peso Weight 32,2 Kg 71 lb
m³ 0,24 m³

Mesa centro ovalada Oval coffee table

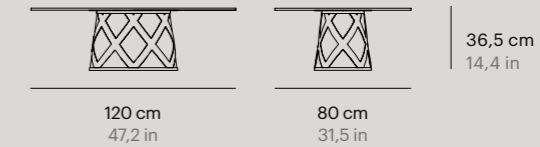

Ref. 77554

Peso Weight 30,4 Kg 67 lb
m³ 0,19 m³

Materiales Materials

Estructura Frame
Aluminio pintado en polvo
Powder coated aluminum

Tapa Top
Porcelánico Porcelanic

Acabados estructura Frame finishes



Acabados tapa Top finishes

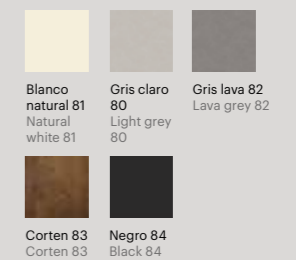

Fennec

Gabriel Teixidó

p. 140

Silla Chair

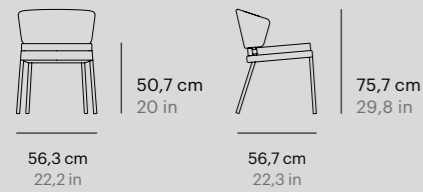

Ref. 74901

Peso Weight 9,5 Kg 20 lb
m³ 0,32 m³

Sillón comedor Dining armchair

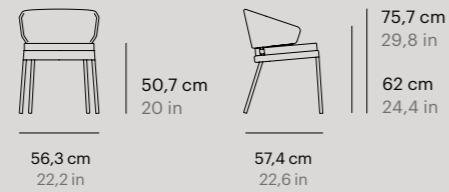

Ref. 74906

Peso Weight 10 Kg 22 lb
m³ 0,32 m³

Mesa comedor Dining table

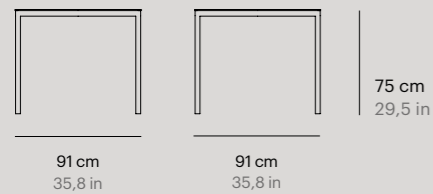

Ref. 74910

Peso con tapa porcelánico 45 Kg
Weight with porcelanic top 99 lb
Peso con tapa compact 35,8 Kg
Weight with HPL top 79 lb
m³ 0,76 m³

Mesa comedor Dining table

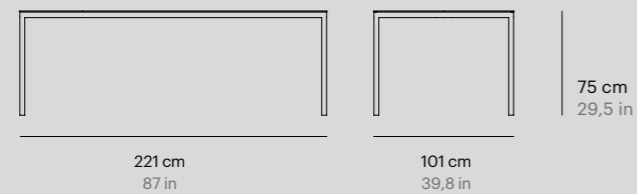

Ref. 74908

Peso con tapa porcelánico 98,1 Kg
Weight with porcelanic top 216 lb
Peso con tapa compact 73,4 Kg
Weight with HPL top 161,8 lb
m³ 1,97 m³

Materiales Materials

Estructura Frame
Aluminio pintado en polvo
Powder coated aluminum
Trenzado Weaving
Flat oval 6 mm
Tapa Top
Porcelánico Porcelanic
Compacto HPL

Acabados trenzado
Weaving finishes

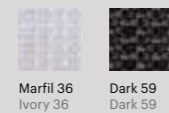

Acabados tapa porcelánico
Porcelanic top finishes

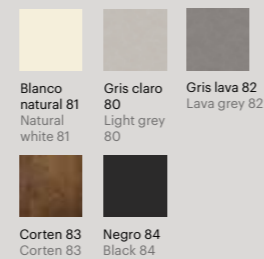

Acabados tapa compacto
HPL top finishes

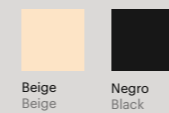

Hamp

Francesc Rifé

p. 94

Sillón comedor Dining armchair

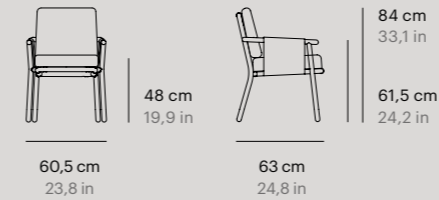

Ref. 76706

Peso Weight 10 Kg 22 lb
m³ 0,4 m³

Sillón Lounge armchair

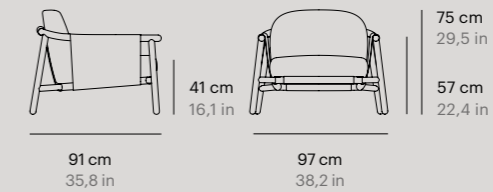

Ref. 76745

Peso Weight 21 Kg 46 lb
m³ 0,86 m³
Cuadrantes Scatter cushions 1 (50x50)

Sofá 2 Sofa 2

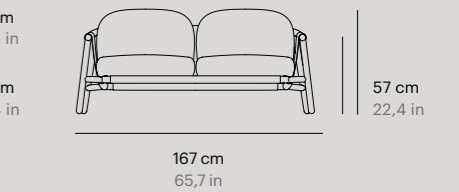

Ref. 76747

Peso Weight 32 Kg 70 lb
m³ 1,44 m³
Cuadrantes Scatter cushions 2 (50x50)

Mesa centro rectangular Rectangular coffee table

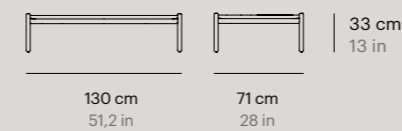

Ref. 76754

Peso Weight 24,5 Kg 54 lb
m³ 0,45 m³

Mesa rincón Corner table

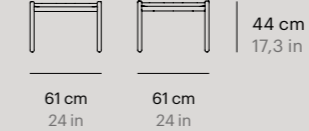

Ref. 76756

Peso Weight 11 Kg 24 lb
m³ 0,25 m³

Mesa comedor Dining table

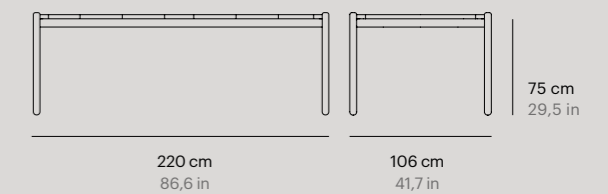

Ref. 76709

Peso Weight 63,4 Kg 139 lb
m³ 1,8 m³

Materiales Materials

Estructura Frame
Teca natural
Natural teak
Telas Fabrics
Batylite

Acabados telas Fabric finishes



Acabado estructura Frame finishes

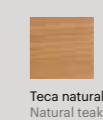

Jazz

POINT Studio
p. 134

Tumbona Sunbed

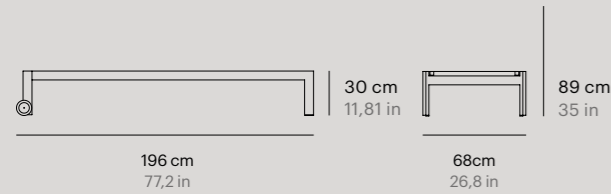

Ref. 73995
 Peso Weight 17,4 Kg 38,4 lb (1pc)
 29,6 Kg 65,3 lb (2pcs)
 m³ 0,75 m³



Mesa auxiliar Auxiliar table

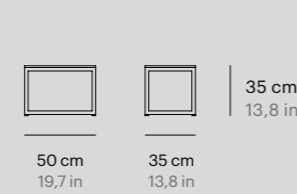

Ref. 73958
 Peso Weight 12 Kg 26 lb
 m³ 0,08 m³

Materiales Materials

Estructura Frame
 Aluminio pintado en polvo
 Powder coated aluminum
Telas Fabrics
 Batylene
Tapa Top
 Compacto HPL

Acabados estructura Frame finishes



Acabados telas Fabrics finishes

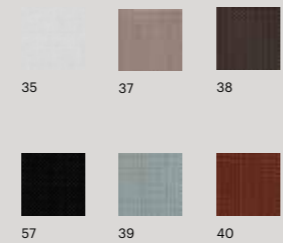

Acabados tapa Top finishes

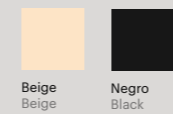

Lineal

Gabriel Teixidó
p. 116

Sillón Armchair

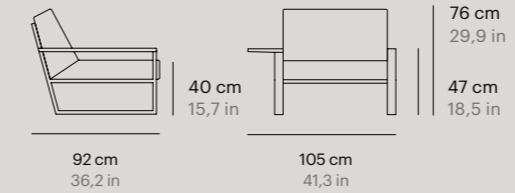

Ref. 76345
 Peso Weight 29 Kg 63 lb
 m³ 0,95 m³
 Cuadrantes Scatter cushions 1 (50x50)

Sofá 2 Sofa 2

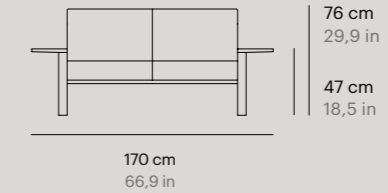

Ref. 76347
 Peso Weight 39 Kg 85 lb
 m³ 1,50 m³
 Cuadrantes Scatter cushions 2 (50x50)

Sofá 3 Sofa 3

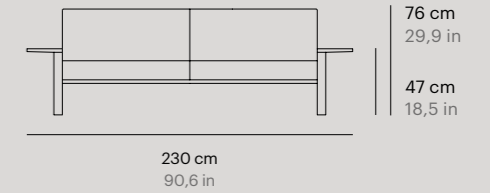

Ref. 76349
 Peso Weight 53,5 Kg 117 lb
 m³ 2 m³
 Cuadrantes Scatter cushions 3 (50x50)

Tumbona Sunbed

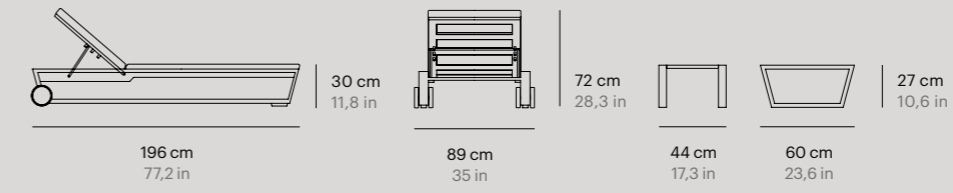

Ref. 76397
 Peso Weight 46 Kg 101,4 lb
 m³ 0,65 m³



Mesa auxiliar Auxiliar table

Ref. 76358
 Peso Weight 7 Kg 15 lb
 m³ 0,12 m³

Mesa centro rectangular Rectangular coffee table



Ref. 76354
 Peso Weight 17 Kg 37 lb
 m³ 0,37 m³

Mesa rincón Corner table

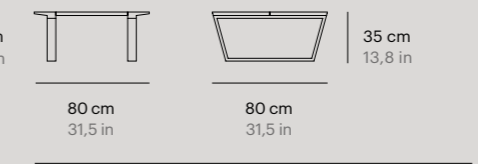

Ref. 76356
 Peso Weight 14,5 Kg 31 lb
 m³ 0,33 m³

Materiales Materials

Estructura Frame
Teca natural
 Natural teak

Acabado Finishes

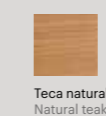

Teca natural
 Natural teak

Min Francesc Rifé

p. 14

Sillón comedor Dining armchair

Sillón Armchair



51 cm
20,08 in



74,5 cm
29,33 in

Ref. 77306

Peso Weight 10 Kg 22 lb
m³ 0,33 m³

Ref. 77345

Peso Weight 16,4 Kg 36,2 lb
m³ 0,86 m³
Cuadrantes Scatter cushions 1 (40x40)

Sofá 2 Sofa 2

Sofá 3 Sofa 3

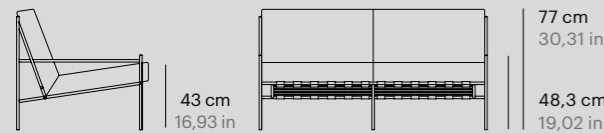

84 cm
33,07 in

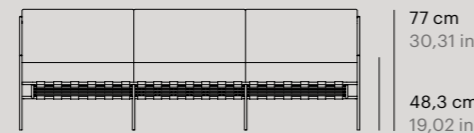

217,1 cm
85,47 in

Ref. 77347

Peso Weight 27,1 Kg 59,7 lb
m³ 1,29 m³
Cuadrantes Scatter cushions 2 (40x40)

Ref. 77349

Peso Weight 36,8 Kg 81,1 lb
m³ 1,66 m³
Cuadrantes Scatter cushions 3(40x40)

Materiales Materials

Estructura Frame
Aluminio pintado en polvo
Powder coated aluminum

Acabados Finishes



Min Francesc Rifé

p. 14

Mesa centro 100x100 Coffee table 100x100

Mesa centro 120x50 Coffe table 120x50

Mesa rincón 50x50 Corner table 50x50



103,6 cm
40,79 in



123,6 cm
48,66 in

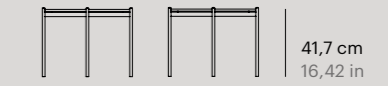

53,6 cm
21,1 in

Ref. 77353

Peso Weight 37,3 Kg 82,3 lb
m³ 0,63 m³

Ref. 77354

Peso Weight 23,4 Kg 51,5 lb
m³ 0,33 m³

Ref. 77356

Peso Weight 10,6 Kg 23,4 lb
m³ 0,17 m³

Mesa comedor 90x90 Dining table 90x90

Mesa comedor 200x100 Dining table 200x100

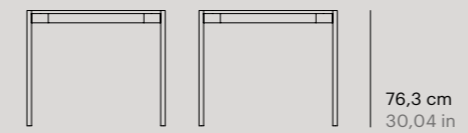

90 cm
35,43 in

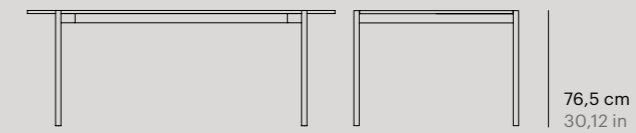

200 cm
78,74 in

Ref. 77310

Peso Weight 39,4 Kg 86,8 lb
m³ 0,96 m³

Ref. 77309

Peso Weight 83,2 Kg 183,4 lb
m³ 1,75 m³

Materiales Materials

Estructura Frame
Aluminio pintado en polvo
Powder coated aluminum
Tapa Top
Porcelánico Porcelanic

Acabados estructura Frame finishes



Acabados tapa Top finishes

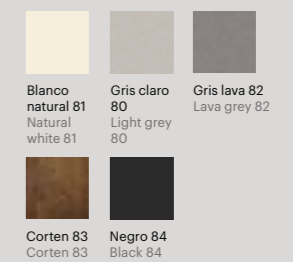

Mist

Estudi{H}ac

p. 208

Lámpara 150 Lamp 150

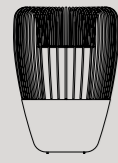

152 cm
59,8 in

Ø 110 cm
Ø 43,3 in

Ref. 76470

Peso Weight 35 Kg 77 lb
m³ 2,01 m³
Potencia Power 9 w

Lámpara 110 Lamp 110



111 cm
43,7 in

Ø 82 cm
Ø 32,3 in

Ref. 76471

Peso Weight 20 Kg 44 lb
m³ 0,81 m³
Potencia Power 6 w

Lámpara 65 Lamp 65



67 cm
26,4 in

Ø 50 cm
Ø 19,7 in

Ref. 76472

Peso Weight 10 Kg 22 lb
m³ 0,22 m³
Potencia Power 6 w

Jardinera 150 Planter 150

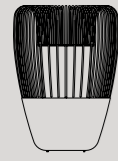

152 cm
59,8 in

Ø 110 cm
Ø 43,3 in

Ref. 76480

Peso Weight 35 Kg 77 lb
m³ 2,01 m³

Jardinera 110 Planter 110



111 cm
43,7 in

Ø 82 cm
Ø 32,3 in

Ref. 76481

Peso Weight 20 Kg 44 lb
m³ 0,81 m³

Jardinera 65 Planter 65



67 cm
26,4 in

Ø 50 cm
Ø 19,7 in

Ref. 76482

Peso Weight 10 Kg 22 lb
m³ 0,22 m³

Materiales Materials

Estructura Frame
Aluminio lacado
Lacquered aluminum
Trenzado Weaving
Round Ø 3 mm

Acabados Finishes

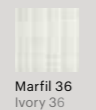

Marfil 36
Ivory 36



Dark 59
Dark 59

Pal

Francesc Rifé

p. 84

Base 92x92 + asiento single Single seat

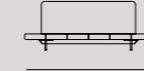

92 cm
36,2 in

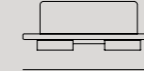

92 cm
36,2 in

34,5 cm
13,6 in

Ref. 7704505

Peso Weight 41,5 Kg 91 lb
m³ 0,64 m³

Base 92x92 + asiento single + resp. single izquierdo Left single seat & back

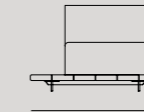

92 cm
36,2 in

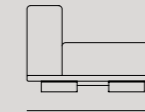

92 cm
36,2 in

60,5 cm
23,8 in
34,5 cm
13,6 in

Ref. 7704502

Peso Weight 48,5 Kg 106 lb
m³ 0,64 m³

Base 92x92 + asiento single + resp. single derecho Right single seat & back

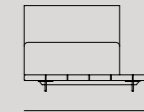

92 cm
36,2 in

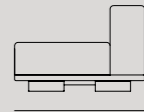

92 cm
36,2 in

60,5 cm
23,8 in
34,5 cm
13,6 in

Ref. 7704501

Peso Weight 48,5 Kg 106 lb
m³ 0,64 m³

Base 92x92 + asiento single + resp. single + brazo derecho Single seat & back + right arm

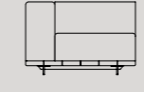

92 cm
36,2 in

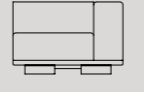

92 cm
36,2 in

60,5 cm
23,8 in
34,5 cm
13,6 in

Ref. 7704504

Peso Weight 55,5 Kg 122 lb
m³ 0,64 m³

Base 92x92 + asiento single + resp. single + brazo izquierdo Single seat & back + left arm

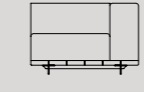

92 cm
36,2 in

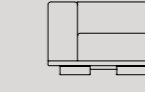

92 cm
36,2 in

60,5 cm
23,8 in
34,5 cm
13,6 in

Ref. 7704503

Peso Weight 55,5 Kg 122 lb
m³ 0,64 m³

Base 184x92 + asiento single + resp. single + brazo derecho Single seat & back + right arm

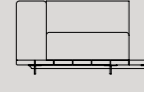

184,4 cm
72,6 in

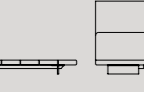

92 cm
36,2 in

60,5 cm
23,8 in
34,5 cm
13,6 in

Ref. 7704706

Peso Weight 88 Kg 194 lb
m³ 0,84 m³

Base 184x92 + asiento single + resp. single + brazo izquierdo Single seat & back + left arm



184,4 cm
72,6 in

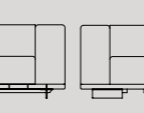

92 cm
36,2 in

60,5 cm
23,8 in
34,5 cm
13,6 in

Ref. 7704705

Peso Weight 88 Kg 194 lb
m³ 0,84 m³

Base 184x92 + asiento single + resp. doble derecha Right double seat & back

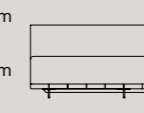

184,4 cm
72,6 in

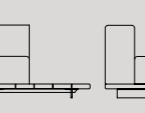

92 cm
36,2 in

60,5 cm
23,8 in
34,5 cm
13,6 in

Ref. 7704701

Peso Weight 93,5 Kg 206 lb
m³ 1,26 m³
Cuadrantes Scatter cushions 1 (50x50)

Base 184x92 + asiento single + resp. doble izquierda Left double seat & back

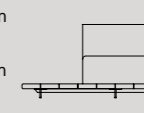

184,4 cm
72,6 in

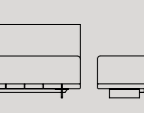

92 cm
36,2 in

60,5 cm
23,8 in
34,5 cm
13,6 in

Ref. 7704702

Peso Weight 93,5 Kg 206 lb
m³ 1,26 m³
Cuadrantes Scatter cushions 1 (50x50)

Materiales Materials

Estructura Frame
Teca natural
Natural teak
Patas Legs
Aluminio pintado en polvo
Powder coated aluminum

Acabado estructura Frame finish



Teca natural
Natural teak

Acabado patas Legs finish



Gris metalizado 56
Gunmetal grey 56

Pal

Francesc Rifé

p. 84

Base 184x92 + asiento doble
+ resp.doble centro
Center seat & back

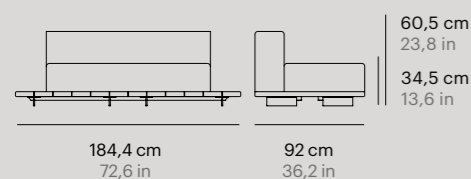

Ref. 7704709

Peso Weight	90,5 Kg 199 lb
m ³	1,26 m ³
Cuadrantes Scatter cushions	1 (50x50)

Base 184x92 + asiento doble + resp.
single + brazo izquierdo
Double seat + single back + left arm



Ref. 7704703

Peso Weight	93,5 Kg 206 lb
m ³	1,26 m ³
Cuadrantes Scatter cushions	1 (50x50)

Base 184x92 + asiento doble
+ resp.single + brazo derecho
Double seat + single back + right arm

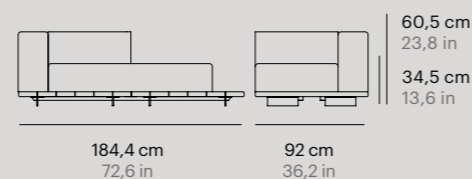

Ref. 7704704

Peso Weight	93,5 Kg 206 lb
m ³	1,26 m ³
Cuadrantes Scatter cushions	1 (50x50)

Base 184x92 + asiento doble
+ resp. doble + brazo izquierdo
Double seat & back + left arm

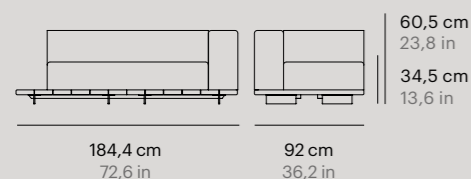

Ref. 7704707

Peso Weight	100,5 Kg 221 lb
m ³	1,26 m ³
Cuadrantes Scatter cushions	1 (50x50)

Base 184x92 + asiento doble
+ resp. doble + brazo derecho
Double seat & back + right arm

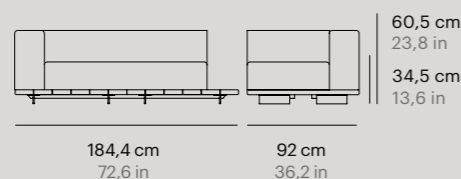

Ref. 7704708

Peso Weight	100,5 Kg 221 lb
m ³	1,26 m ³
Cuadrantes Scatter cushions	1 (50x50)

Base 184x92 + asiento y resp. doble
+ brazo izq. a la derecha
Double seat & back + left arm to right

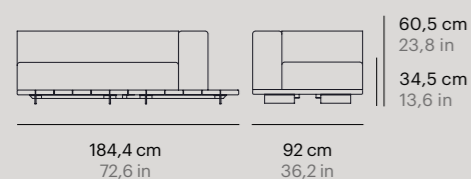

Ref. 7704710

Peso Weight	100,5 Kg 221 lb
m ³	1,26 m ³
Cuadrantes Scatter cushions	1 (50x50)

Base 184x92 + asiento y resp. doble
+ brazo der. a la izquierda
Double seat & back + right arm to left

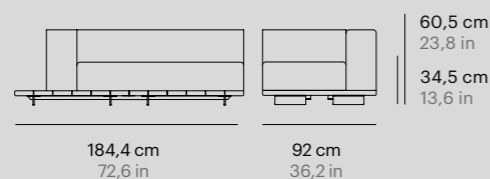

Ref. 7704711

Peso Weight	100,5 Kg 221 lb
m ³	1,26 m ³
Cuadrantes Scatter cushions	1 (50x50)

Materiales Materials

Estructura Frame

Teca natural
Natural teak

Patas Legs

Aluminio pintado en polvo
Powder coated aluminum

Acabado estructura Frame finish



Teca natural
Natural teak

Acabado patas Legs finish



Gris metalizado 56
Gunmetal grey 56

Pal

Francesc Rifé

p. 84

Base 246x92 + asiento doble + resp.
doble izquierdo Left double seat & back

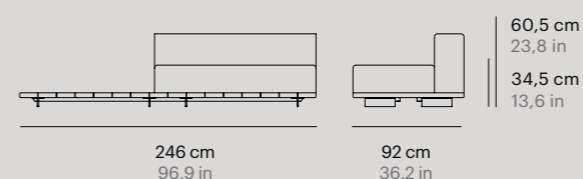

Ref. 7704902

Peso Weight	111,5 Kg 245 lb
m ³	1,38 m ³
Cuadrantes Scatter cushions	1 (50x50)

Base 246x92 + asiento doble + resp.
doble derecho Right double seat & back

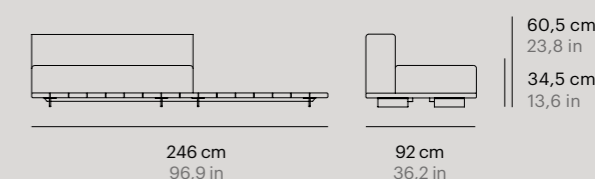

Ref. 7704901

Peso Weight	111,5 Kg 245 lb
m ³	1,38 m ³
Cuadrantes Scatter cushions	1 (50x50)

Base 246x92 + asiento doble
+ resp. doble + brazo izquierdo
Double seat & back + left arm

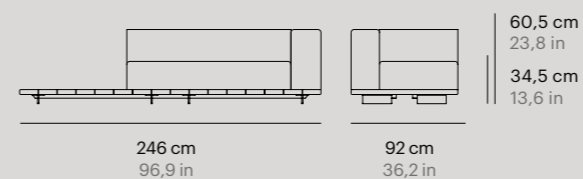

Ref. 7704904

Peso Weight	118,5 Kg 261 lb
m ³	1,38 m ³
Cuadrantes Scatter cushions	1 (50x50)

Base 246x92 + asiento doble
+ resp. doble + brazo derecho
Double seat & back + right arm

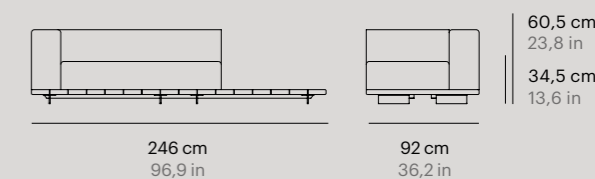

Ref. 7704903

Peso Weight	118,5 Kg 261 lb
m ³	1,38 m ³
Cuadrantes Scatter cushions	1 (50x50)

Base 246x92 + asiento y respaldo doble
+ asiento y respaldo single izquierdo
Left double seat & back + single seat & back

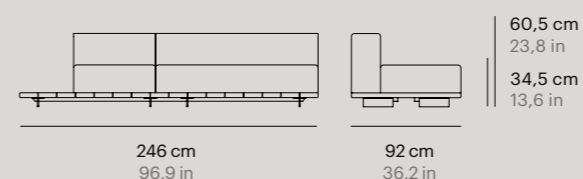

Ref. 7704907

Peso Weight	128,5 Kg 283 lb
m ³	1,84 m ³
Cuadrantes Scatter cushions	1 (50x50)

Base 246x92 + asiento y respaldo doble
+ asiento y respaldo single derecho
Right double seat & back + single seat & back

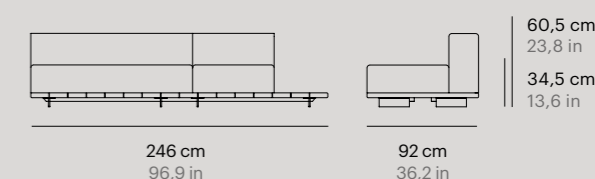

Ref. 7704908

Peso Weight	128,5 Kg 283 lb
m ³	1,84 m ³
Cuadrantes Scatter cushions	1 (50x50)

Materiales Materials

Estructura Frame

Teca natural
Natural teak

Patas Legs

Aluminio pintado en polvo
Powder coated aluminum

Acabado estructura Frame finish



Teca natural
Natural teak

Acabado patas Legs finish



Gris metalizado 56
Gunmetal grey 56

Pal

Francesc Rifé

p. 84

Base 246x92 + asiento y respaldo doble
+ asiento single + brazo izquierdo
Double seat & back + single seat + left arm

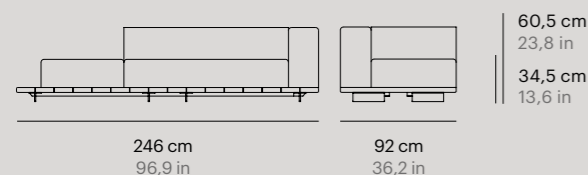

Ref. 7704909

Peso Weight	128,5 Kg 283 lb
m ³	1,84 m ³
Cuadrantes Scatter cushions	1 (50x50)

Base 246x92 + asiento y resp. doble
+ asiento y resp. single + brazo izquierdo
Double seat & back + single seat & back + left arm

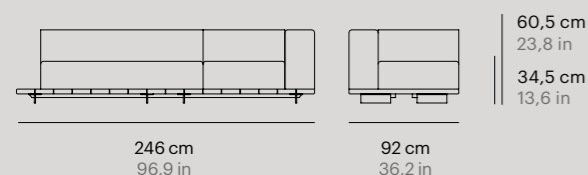

Ref. 7704905

Peso Weight	135,5 Kg 298 lb
m ³	1,84 m ³
Cuadrantes Scatter cushions	1 (50x50)

Base 246x92 + sofá 2 completo derecha
Right complete sofa 2

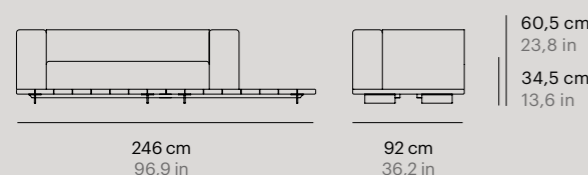

Ref. 7704911

Peso Weight	120 Kg 264 lb
m ³	1,35 m ³
Cuadrantes Scatter cushions	1 (50x50)

Materiales Materials

Estructura Frame
Teca natural
Natural teak
Patas Legs
Aluminio pintado en polvo
Powder coated aluminum

Acabado estructura Frame finish



Teca natural
Natural teak

Acabado patas Legs finish



Gris metalizado 56
Gunmetal grey 56

Base 246x92 + asiento y respaldo doble
+ asiento single + brazo derecho
Double seat & back + single seat + right arm

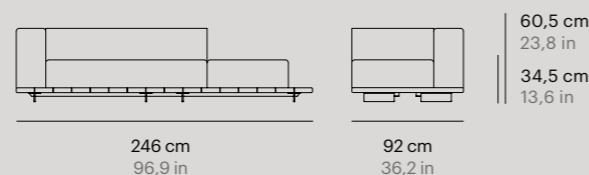

Ref. 7704910

Peso Weight	128,5 Kg 283 lb
m ³	1,84 m ³
Cuadrantes Scatter cushions	1 (50x50)

Base 246x92 + asiento doble
+ resp. doble + brazo derecho
Double seat & back + right arm

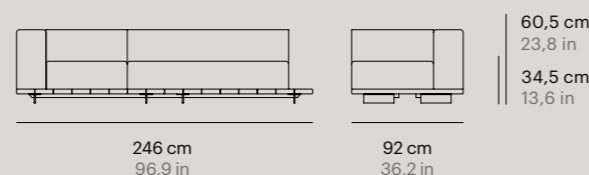

Ref. 7704906

Peso Weight	135,5 Kg 298 lb
m ³	1,84 m ³
Cuadrantes Scatter cushions	1 (50x50)

Base 246x92 + sofá 2 completo izquierda
Left complete sofa 2

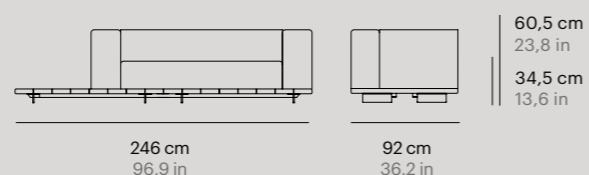

Ref. 7704912

Peso Weight	120 Kg 264 lb
m ³	1,35 m ³
Cuadrantes Scatter cushions	1 (50x50)

Pal

Francesc Rifé

p. 84

Base 246x92 + asiento y respaldo single izquierda
+ asiento doble
Base 246x92 + right single seat & back + double seat

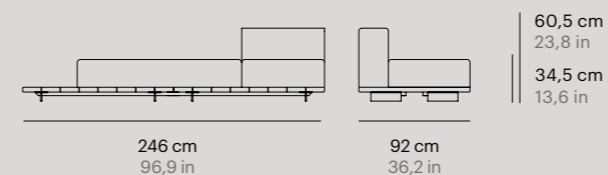

Ref. 7704913

Peso Weight	107 Kg 235 lb
m ³	1,35 m ³
Cuadrantes Scatter cushions	1 (50x50)

Base 246x92 + asiento y resp. doble + asiento
y resp. simple + brazo izq. a la derecha
Double seat & back + single seat & back + left arm to right

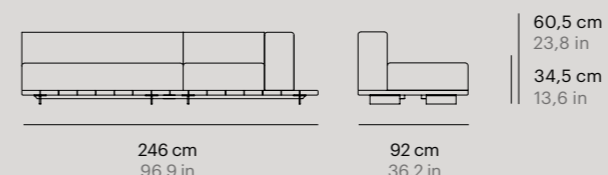

Ref. 7704915

Peso Weight	135,5 Kg 298 lb
m ³	1,35 m ³
Cuadrantes Scatter cushions	1 (50x50)

Base 246x92 + asiento y respaldo doble derecha
+ asiento single
Right double seat & back + single seat

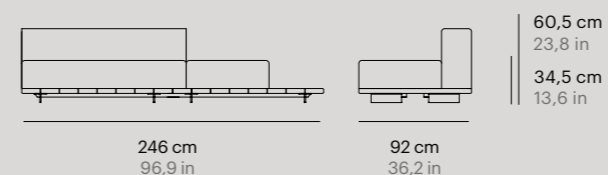

Ref. 7704917

Peso Weight	115 Kg 253 lb
m ³	1,35 m ³
Cuadrantes Scatter cushions	1 (50x50)

Materiales Materials

Estructura Frame
Teca natural
Natural teak
Patas Legs
Aluminio pintado en polvo
Powder coated aluminum

Acabado estructura Frame finish



Teca natural
Natural teak

Acabado patas Legs finish



Gris metalizado 56
Gunmetal grey 56

Base 246x92 + asiento y respaldo single derecha
+ asiento doble
Base 246x92 + left single seat & back + double seat

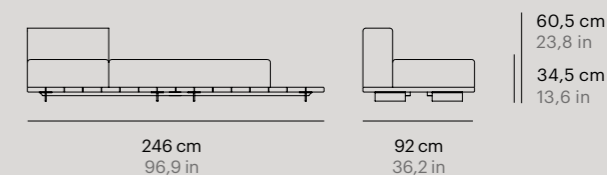

Ref. 7704914

Peso Weight	107 Kg 235 lb
m ³	1,35 m ³
Cuadrantes Scatter cushions	1 (50x50)

Base 246x92 + asiento y resp. doble + asiento
y resp. simple + brazo dcho. a la izquierda
Double seat & back + single seat & back + right arm to left

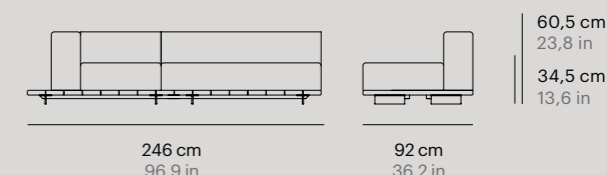

Ref. 7704916

Peso Weight	135,5 Kg 298 lb
m ³	1,35 m ³
Cuadrantes Scatter cushions	1 (50x50)

Pal

Francesc Rifé

p. 84

Base 185x185 + asiento tumbona Sunbed seat

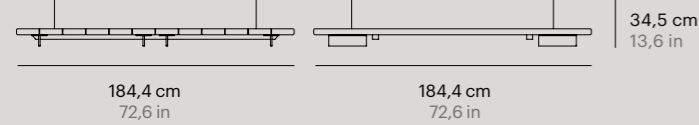

Ref. 7709502

Peso Weight 150,5 Kg 331 lb
m³ 2,1 m³

Base 185x185 + asiento tumbona + resp. doble + brazo izquierdo Sunbed seat + double back + left arm

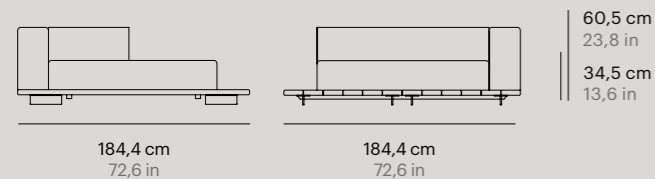

Ref. 7709503

Peso Weight 170,5 Kg 375 lb
m³ 2,1 m³

Base 185x185 + 2 asiento doble + 2 respaldo single vis a vis 2 vis a vis double seat + single back



Ref. 7709505

Peso Weight 162 Kg 357 lb
m³ 2,5 m³

Materiales Materials

Estructura Frame
Teca natural
Natural teak
Patas Legs
Aluminio pintado en polvo
Powder coated aluminum

Acabado estructura Frame finish

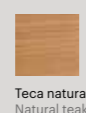

Teca natural
Natural teak

Acabado patas Legs finish

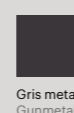

Gris metalizado 56
Gunmetal grey 56

Base 185x185 + asiento tumbona + resp. doble Sunbed seat + double back

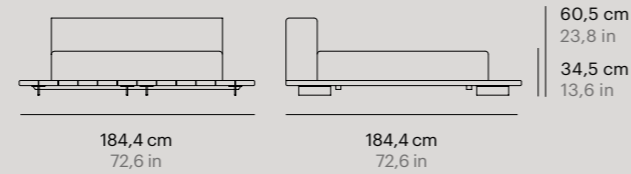

Ref. 7709501

Peso Weight 166,5 Kg 367 lb
m³ 2,1 m³

Base 185x185 + asiento tumbona + resp. doble + brazo derecho Sunbed seat + double back + right arm

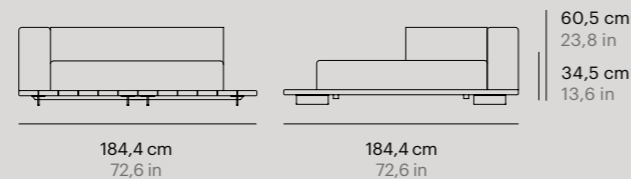

Ref. 7709504

Peso Weight 170,5 Kg 375 lb
m³ 2,1 m³

Base 185x185 + asiento doble + 2 respaldo single paralelos 2 parallel double seat + 2 single back

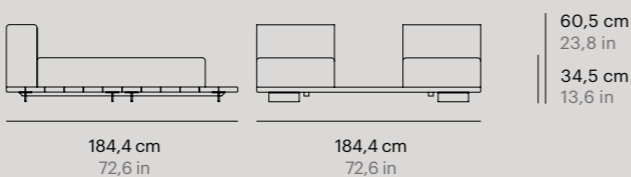

Ref. 7709506

Peso Weight 162 Kg 357 lb
m³ 2,5 m³

Pal

Francesc Rifé

p. 84

Mesa redonda 28 Round table 28



Ref. 77015

Peso Weight 4,3 Kg 9 lb
m³ 0,03 m³

Mesa redonda 42 Round table 42



Ref. 77014

Peso Weight 7,2 Kg 15 lb
m³ 0,03 m³

Mesa rectangular 50 Rectangular table 50

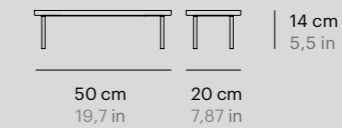

Ref. 77017

Peso Weight 5 Kg 11 lb
m³ 0,03 m³

Mesa rectangular 65 Rectangular table 65

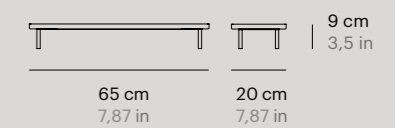

Ref. 77016

Peso Weight 6,8 Kg 14 lb
m³ 0,03 m³

Materiales Materials

Tapa Top
Granito
Granite
Patas Legs
Aluminio pintado en polvo
Powder coated aluminum

Acabado tapa Top finish

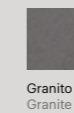

Granito
Granite

Acabado patas Legs finish

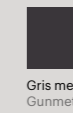

Gris metalizado 56
Gunmetal grey 56

Mesa tapa teca Teak top table

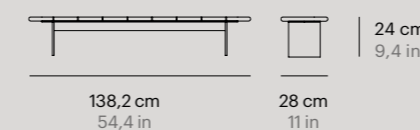

Ref. 77054

Peso Weight 16,5 Kg 36 lb
m³ 0,16 m³

Mesa tapa teca Teak top table

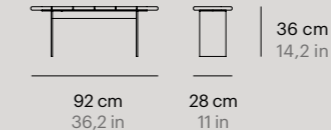

Ref. 77055

Peso Weight 14 Kg 30 lb
m³ 0,15 m³

Mesa tapa teca Teak top table

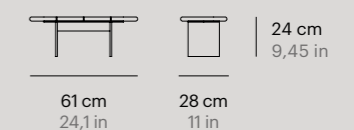

Ref. 77056

Peso Weight 9 Kg 19 lb
m³ 0,11 m³

Materiales Materials

Tapa Top
Teca
Teak
Patas Legs
Aluminio pintado en polvo
Powder coated aluminum

Acabado tapa Top finish

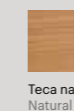

Teca natural
Natural teak

Acabado patas Legs finish

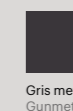

Gris metalizado 56
Gunmetal grey 56

Pal

Francesc Rifé

p. 84

Mesa tapa teca Teak top table

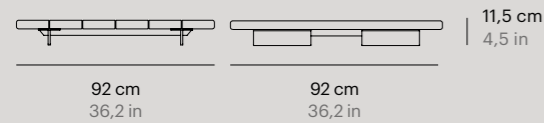

Ref. 77050

Peso Weight **31,5 Kg 69 lb**
m³ **0,18 m³**

Mesa tapa teca Teak top table

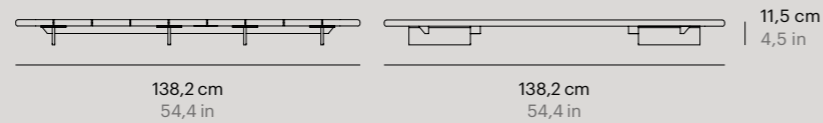

Ref. 77053

Peso Weight **51 Kg 112 lb**
m³ **0,44 m³**

Mesa tapa teca Teak top table

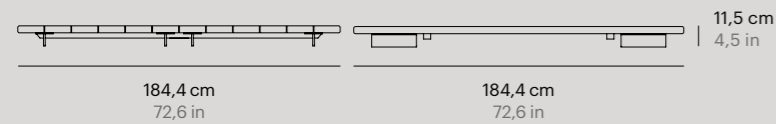

Ref. 77057

Peso Weight **115 Kg 253 lb**
m³ **0,74 m³**

Mesa tapa teca Teak top table

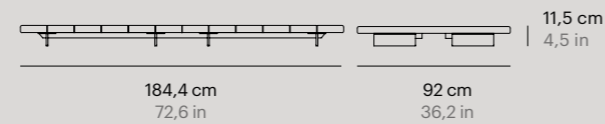

Ref. 77051

Peso Weight **64 Kg 141 lb**
m³ **0,38 m³**

Mesa tapa teca Teak top table

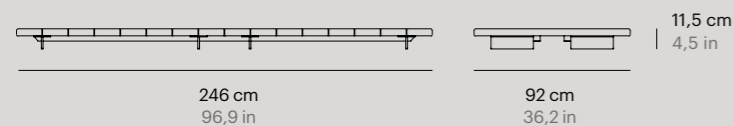

Ref. 77052

Peso Weight **82 Kg 180 lb**
m³ **0,5 m³**

Materiales Materials

Tapa Top
Teca
Teak
Patas Legs
Aluminio pintado en polvo
Powder coated aluminum

Acabado tapa Top finish



Teca natural
Natural teak

Acabado patas Legs finish



Gris metalizado 56
Gunmetal grey 56

Pul

Francesc Rifé

p. 84

Mesa metal Metal table



Ref. 76658

Peso Weight **16,5 Kg 36 lb**
m³ **0,11 m³**

Materiales Materials

Estructura Frame
Aluminio pintado en polvo
Powder coated aluminum

Acabados Finishes



Round

Francesc Rifé

p. 148

Silla Chair



Ref. 76501

Peso Weight **9,5 Kg (1pc) 20 lb (1pc)**
16,5 Kg (2pc) 36 lb (2pc)
m³ **0,34 m³ (1pc) - 0,37 m³ (2pc)**

Sillón club Club armchair

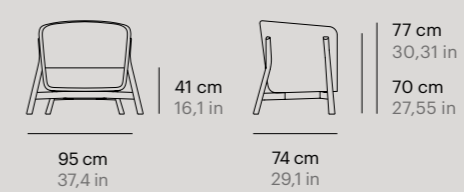

Ref. 76544

Peso Weight **26,5 Kg 58 lb**
m³ **0,74 m³**
Cuadrantes Scatter cushions **1 (50x50)**

Taburete bar Bar stool

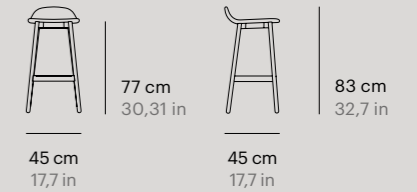

Ref. 76552

Peso Weight **13 Kg 28 lb**
m³ **0,26 m³**

Materiales Materials

Estructura Frame
Aluminio lacado Lacquered aluminum
Trenzado Weaving
Round Ø 3 mm
Patas Legs
Teca natural Natural teak

Acabados trenzado Weaving finishes



Marfil 36
Ivory 36



Multicolor 10
Multicolor 10

Acabado patas Legs finish



Teca
Teak

Round

Francesc Rifé

p. 148

Sillón Armchair

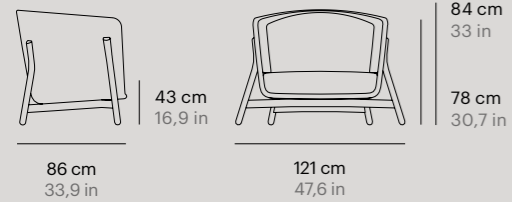

Ref. 76545

Peso Weight	32,5 Kg 71 lb
m ³	1,18 m ³
Cuadrantes Scatter cushions	1 (70x60) - 1 (50x50)

Materiales Materials

Estructura Frame
Aluminio lacado Lacquered aluminum

Trenzado Weaving
Round Ø 3 mm

Patas Legs
Teca natural Natural teak

Sofá 2 Sofa 2

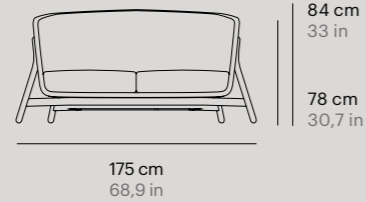

Ref. 76547

Peso Weight	45 Kg 99 lb
m ³	1,67 m ³
Cuadrantes Scatter cushions	2 (70x60) - 2 (50x50)

Sofá 3 Sofá 3

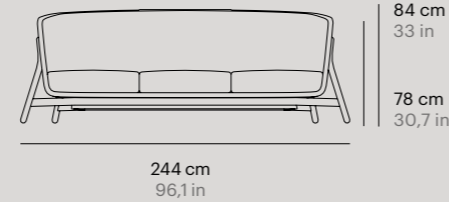

Ref. 76549

Peso Weight	73 Kg 160 lb
m ³	1,94 m ³
Cuadrantes Scatter cushions	3 (70x60) - 3 (50x50)

Mesa auxiliar Auxiliar table



Ref. 76557

Peso con tapa porcelánico Weight with porcelanic top	10,41 Kg 22 lb
Peso con tapa compacto Weight with HPL top	7,3 Kg 16 lb
m ³	0,22 m ³

Materiales Materials

Tapa Top
Porcelánico Porcelanic
Compacto HPL

Patas Legs
Teca Teak

Acabados tapa porcelánico Porcelanic top finishes

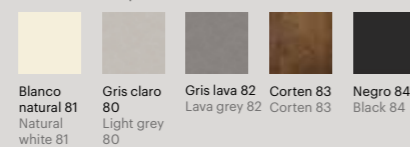

Acabados tapa compacto HPL top finishes

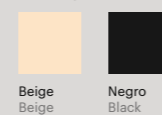

Acabado patas Legs finish

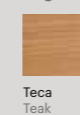

Acabados trenzado Weaving finishes

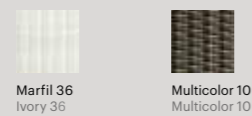

Acabado patas Legs finish

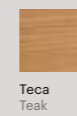

Mesa de centro Coffee table



Ref. 76555

Peso con tapa porcelánico Weight with porcelanic top	20,7 Kg 45 lb
Peso con tapa compacto Weight with HPL top	13,6 Kg 29 lb
m ³	0,35 m ³

Mesa de centro Coffee table



Ref. 76553

Peso con tapa porcelánico Weight with porcelanic top	40 Kg 88 lb
Peso con tapa compacto Weight with HPL top	27,5 Kg 60 lb
m ³	0,6 m ³

Round

Francesc Rifé

p. 148

Mesa comedor Dining table

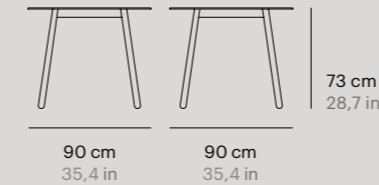

Ref. 76515

Peso con tapa porcelánico Weight with porcelanic top	28,6 Kg 63 lb
Peso con tapa compacto Weight with HPL top	20,1 Kg 44 lb
m ³	0,1 m ³

Mesa comedor Dining table

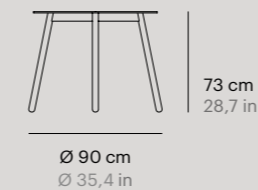

Ref. 76517

Peso con tapa porcelánico Weight with porcelanic top	27,9 Kg 61 lb
Peso con tapa compacto Weight with HPL top	20,8 Kg 45 lb
m ³	0,1 m ³

Materiales Materials

Tapa Top
Porcelánico Porcelanic
Compacto HPL

Patas Legs
Teca Teak

Mesa comedor Dining table

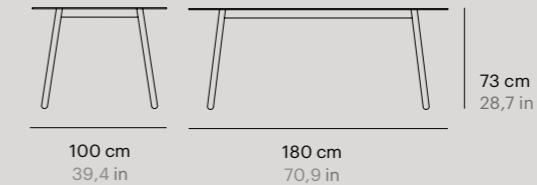

Ref. 76509

Peso con tapa porcelánico Weight with porcelanic top	58,9 Kg 129 lb
Peso con tapa compacto Weight with HPL top	40,4 Kg 89 lb
m ³	0,2 m ³

Mesa comedor Dining table

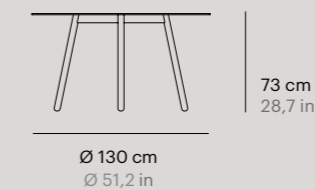

Ref. 76513

Peso con tapa porcelánico Weight with porcelanic top	42,4 Kg 93 lb
Peso con tapa compacto Weight with HPL top	27,6 Kg 60 lb
m ³	0,19 m ³

Acabados tapa porcelánico Porcelanic top finishes

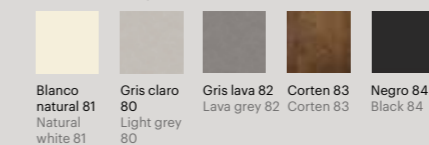

Mesa comedor Dining table

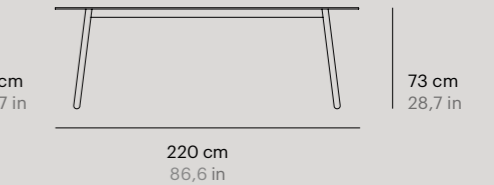

Ref. 76507

Peso con tapa porcelánico Weight with porcelanic top	69,1 Kg 152 lb
Peso con tapa compacto Weight with HPL top	46,4 Kg 102 lb
m ³	0,24 m ³

Acabados tapa compacto HPL top finishes

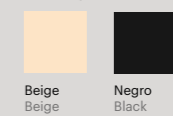

Acabado patas Legs finish

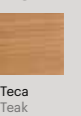

Sir

Francesc Rifé

p. 44

Sillón Armchair

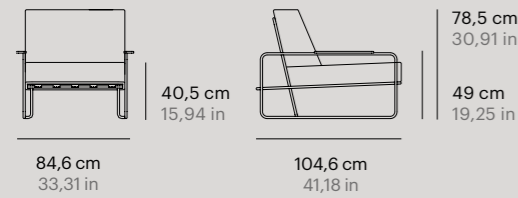

Ref. 77245

Peso Weight 22,6 Kg 49,8 lb
m³ 0,86 m³
Cuadrantes Scatter cushions 1(50x50)

Puff Ottoman



Ref. 77252

Peso Weight 6,7 Kg 14,8 lb
m³ 0,14 m³

Materiales Materials

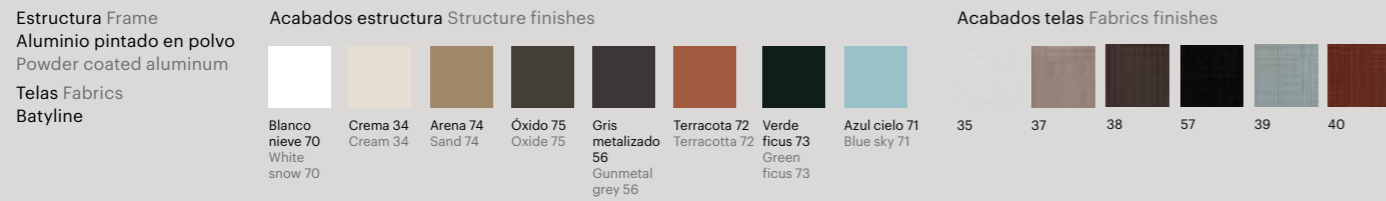

Sunset

Esther Campos

p. 194

Tumbona doble sin cortinas Double sunbed with no curtains

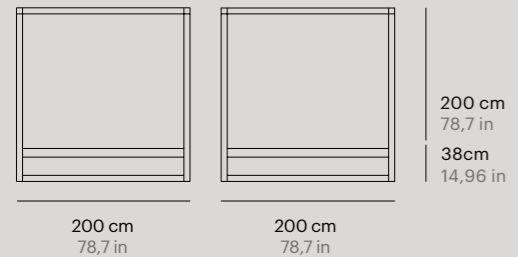

Ref. 74495

Peso Weight 106,5 Kg 234,8 lb
m³ 2,57 m³

Tumbona doble con cortinas Double sunbed with curtains

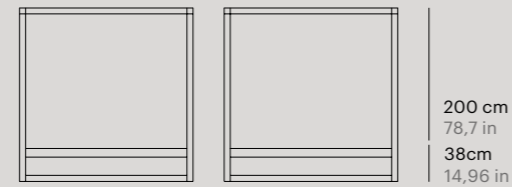

Ref. 74496

Peso Weight 113,5 Kg 250,2 lb
m³ 2,57 m³

Materiales Materials



T

Gabriel Teixidó

p. 52

Sillón Armchair

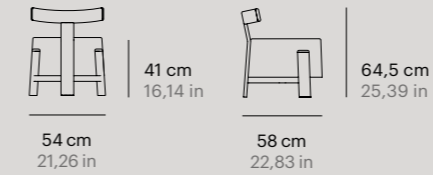

Ref. 77407

Peso Weight 12,7 Kg 28,0 lb
m³ 0,33 m³

Taburete bar Bar stool

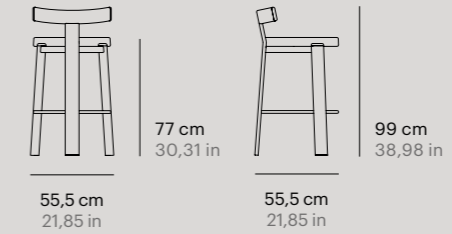

Ref. 77451

Peso Weight 10,1 Kg 22,2 lb
m³ 0,37 m³

Puff Ottoman



Ref. 77452

Peso Weight 8,7 Kg 19,2 lb
m³ 0,14 m³

Mesa Table

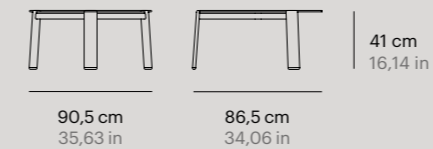

Ref. 77456

Peso Weight 16,2 Kg 35,6 lb
m³ 0,53 m³

Materiales Materials



Tub

Gabriel Teixidó

p. 106

Silla Chair

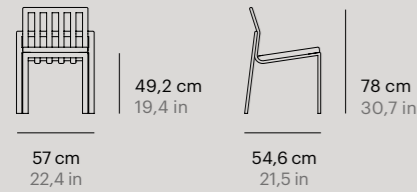

Ref. 74801



Peso Weight 8 Kg (1pc) 17 lb (1pc)
m³ 33 Kg (4pc) 73 lb (4pc)
0,32 m³ (1pc) - 0,4 m³ (4pc)

Sillón comedor Dining armchair



Ref. 74806

Peso Weight 9 Kg 19 lb
m³ 0,32 m³

Sillón Armchair

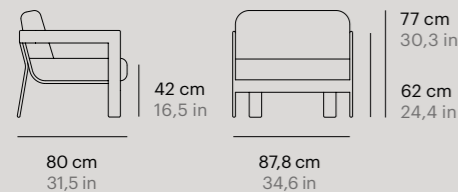

Ref. 74845

Peso Weight 19 Kg 41 lb
m³ 0,55 m³
Cuadrantes Scatter cushions 1 (50x50)

Sofá 2 Sofa 2

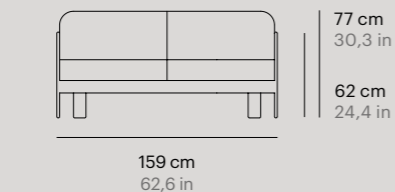

Ref. 74847

Peso Weight 40 Kg 88 lb
m³ 0,96 m³
Cuadrantes Scatter cushions 2 (50x50)

Sofá 3 Sofa 3

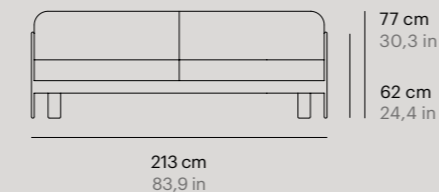

Ref. 74849

Peso Weight 52,5 Kg 115 lb
m³ 1,28 m³
Cuadrantes Scatter cushions 2 (50x50)

Materiales Materials

Estructura Frame
Aluminio pintado en polvo
Powder coated aluminum

Acabados Finishes



Tub

Gabriel Teixidó

p. 106

Mesa centro Coffee table

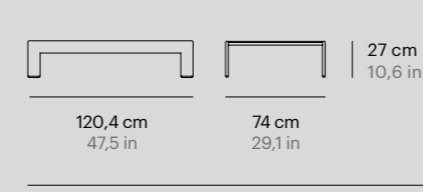

Ref. 74854

Peso con tapa porcelánica 32 Kg
Weight with porcelanic top 70 lb
Peso con tapa compact 22,8 Kg
Weight with HPL top 50 lb
m³ 0,33 m³

Mesa rincón Corner table

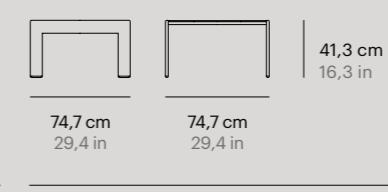

Ref. 74856

Peso con tapa porcelánica 21,5 Kg
Weight with porcelanic top 47 lb
Peso con tapa compact 15,8 Kg
Weight with HPL top 34 lb
m³ 0,31 m³

Mesa comedor cuadrada Square dining table

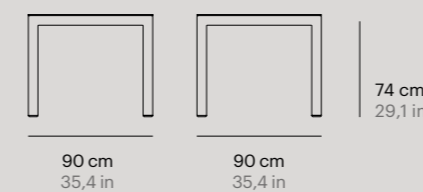

Ref. 74810

Peso con tapa porcelánica 38,4 Kg
Weight with porcelanic top 84 lb
Peso con tapa compact 29,4 Kg
Weight with HPL top 64 lb
m³ 0,74 m³

Mesa comedor rectangular Rectangular dining table

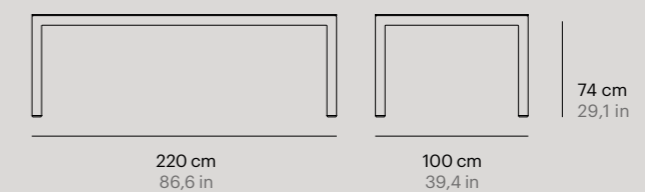

Ref. 74809

Peso con tapa porcelánica 85,5 Kg
Weight with porcelanic top 188 lb
Peso con tapa compact 61,1 Kg
Weight with HPL top 134 lb
m³ 1,92 m³

Materiales Materials

Estructura Frame
Aluminio pintado en polvo
Powder coated aluminum

Tapa Top
Porcelánico Porcelanic
Compacto HPL

Acabados estructura Frame finishes



Acabados tapa porcelánico Porcelanic top finishes

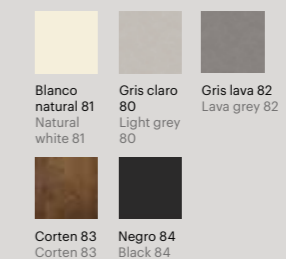

Acabados tapa compacto HPL top finishes

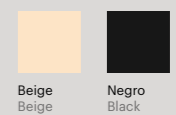

U Gabriel Teixidó

p. 176

Silla Chair

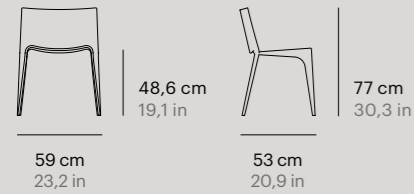

Ref. 74101

Peso Weight **8,5 Kg (1pc) 18 lb (1pc)**
36 Kg (4pc) 79 lb (4pc)
 m³ **0,28 m³ (1pc) - 0,44 m³ (4pc)**



Sillón Armchair

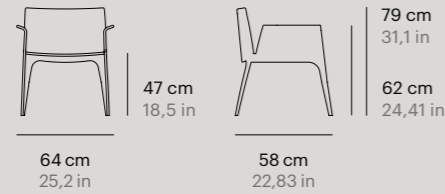

Ref. 74106

Peso Weight **9 Kg 19 lb**
 m³ **0,24 m³**

Sillón club Club armchair

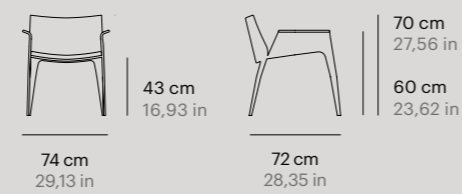

Ref. 74107

Peso Weight **8 Kg 17 lb**
 m³ **0,37 m³**

Sillón respaldo alto High back armchair

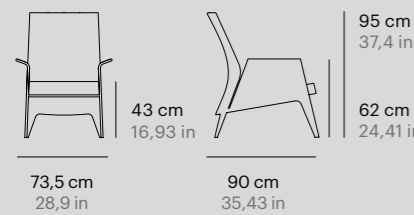

Ref. 74246

Peso Weight **12 Kg 26 lb**
 m³ **0,64 m³**
 Cuadrantes Scatter cushions **1 (50x50)**

Taburete bar Bar stool

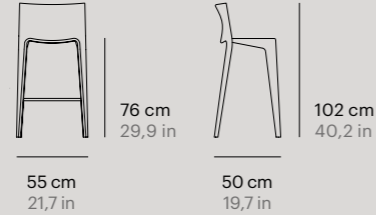

Ref. 74257

Peso Weight **9,5 Kg 20 lb**
 m³ **0,22 m³**

Sillón Armchair

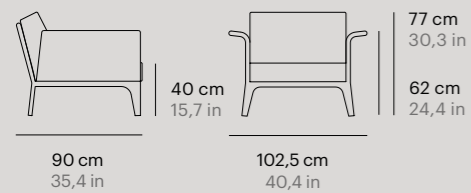

Ref. 74245

Peso Weight **19 Kg 41 lb**
 m³ **0,73 m³**
 Cuadrantes Scatter cushions **1 (50x50)**

Sofá 2 Sofa 2

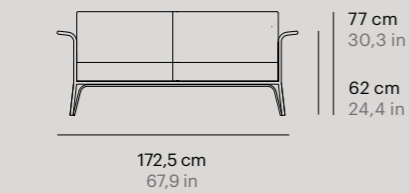

Ref. 74247

Peso Weight **32 Kg 70 lb**
 m³ **1,21 m³**
 Cuadrantes Scatter cushions **2 (50x50)**

Sofá 3 Sofa 3

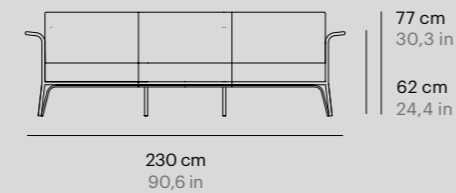

Ref. 74249

Peso Weight **42 Kg 92 lb**
 m³ **1,57 m³**
 Cuadrantes Scatter cushions **3 (50x50)**

U Gabriel Teixidó

p. 176

Tumbona Sunbed

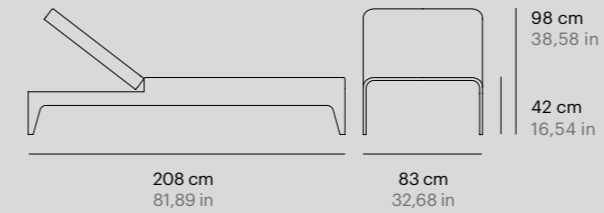

Ref. 74195

Peso Weight **25 Kg 55 lb**
 m³ **0,73 m³**



Puff Ottoman

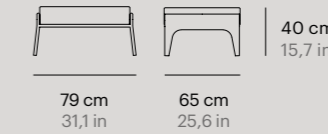

Ref. 74252

Peso Weight **7 Kg 15 lb**
 m³ **0,34 m³**

Mesa centro Coffee table



Ref. 74253

Peso Weight **8 Kg s. cristal 17 lb no glass**
19 Kg c. cristal 41 lb w. glass
 m³ **0,25 m³ s. cristal no glass**
0,26 m³ c. cristal w. glass

Mesa centro Coffee table



Ref. 74254

Peso Weight **12 Kg s. cristal 26 lb no glass**
20 Kg c. cristal 44 lb w. glass
 m³ **0,35 m³ s. cristal no glass**
0,36 m³ c. cristal w. glass

Mesa auxiliar Auxiliar table



Ref. 74258

Peso Weight **5 Kg s. cristal 11 lb no glass**
12 Kg c. cristal 26 lb w. glass
 m³ **0,15 m³ s. cristal no glass**
0,16 m³ c. cristal w. glass

Mesa club Club table

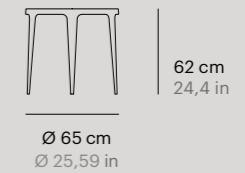

Ref. 74115

Peso Weight **8 Kg s. cristal 17,6 lb no glass**
15 Kg c. cristal 33 lb w. glass
 m³ **0,5 m³ s. cristal no glass**
0,51 m³ c. cristal w. glass

Mesa alta High table

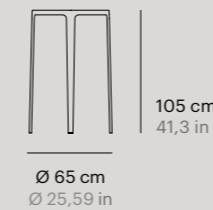

Ref. 74116

Peso Weight **19 Kg s. cristal 41 lb no glass**
23,8 Kg c. cristal 52 lb w. glass
 m³ **0,48 m³ s. cristal no glass**
0,49 m³ c. cristal w. glass

Mesa comedor cuadrada Square dining table

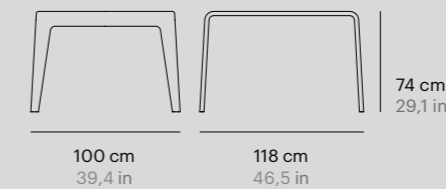

Ref. 74110

Peso Weight **21,5 Kg s. cristal 47 lb no glass**
36,5 Kg c. cristal 80 lb w. glass
 m³ **1,05 m³ s. cristal no glass**
1,06 m³ c. cristal w. glass

Mesa comedor rectangular Rectangular dining table

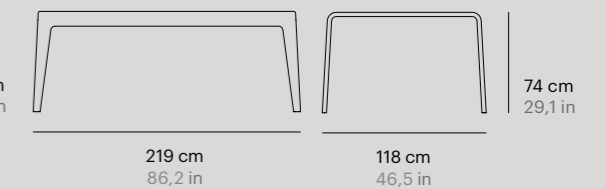

Ref. 74109

Peso Weight **34,5 Kg s. cristal 76 lb no glass**
64 Kg c. cristal 142 lb w. glass
 m³ **2,04 m³ s. cristal no glass**
2,05 m³ c. cristal w. glass

Materiales Materials

Estructura Frame
 Aluminio lacado
 Lacquered aluminum

Trenzado Weaving
 Flat oval 6 mm

Acabados Finishes



Marfil 36
Ivory 36



Tostado 03
Toasted 03



Dark 59
Dark 59

Weave

Vicent Martínez

p. 60

Silla Chair

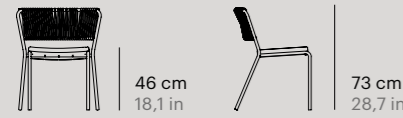

57,5 cm
22,6 in

46 cm
18,1 in

73 cm
28,7 in

54,5 cm
21,5 in

Ref. 77101



Peso Weight 7,7 Kg (1pc) 17 lb (1pc)
24,5 Kg (4pc) 54 lb (4pc)
m³ 0,34 m³ (1pc) - 0,36 m³ (4pc)

Sillón comedor Dinning armchair

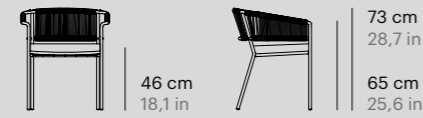

63,5 cm
25 in

46 cm
18,1 in

73 cm
28,7 in

65 cm
25,6 in

54,5 cm
21,5 in

Ref. 77106

Peso Weight 11,5 Kg 25 lb
m³ 0,33 m³

Sillón comedor Dinning armchair

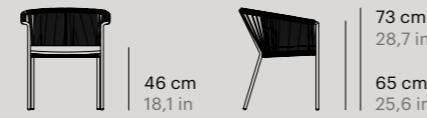

63,5 cm
25 in

46 cm
18,1 in

73 cm
28,7 in

65 cm
25,6 in

54,5 cm
21,5 in

Ref. 77107

Peso Weight 12 Kg 26 lb
m³ 0,33 m³

Sillón club Club armchair



72 cm
28,3 in

41 cm
16,1 in

77 cm
30,3 in

72 cm
28,3 in

65 cm
25,6 in

Ref. 77108

Peso Weight 16,5 Kg 36 lb
m³ 0,47 m³

Sofá 2 club Club sofa 2

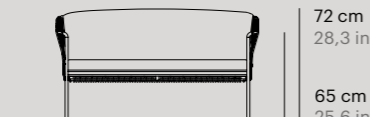

132 cm
52 in

72 cm
28,3 in

65 cm
25,6 in

Ref. 77167

Peso Weight 23 Kg 50 lb
m³ 0,78 m³

Taburete bar Bar stool



100 cm
39,4 in

74 cm
29,1 in

90 cm
35,4 in

60 cm
23,6 in

54 cm
21,3 in

Ref. 77152

Peso Weight 13 Kg 28,7 lb
m³ 0,78 m³

Sillón Armchair



82 cm
32,28 in

40 cm
15,75 in

81 cm
31,89 in

83 cm
32,68 in

56 cm
22,05 in

Ref. 78145

Peso Weight 23 Kg 50,6 lb
m³ 0,62 m³
Cuadrantes Scatter cushions 1(40x40) - 1(60x60)

Sofá 2 Sofa 2

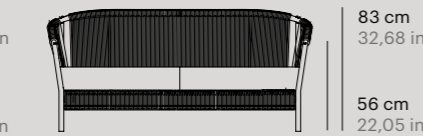

162 cm
63,78 in

83 cm
32,68 in

56 cm
22,05 in

Ref. 78147

Peso Weight 44,8 Kg 98,7 lb
m³ 1,21 m³
Cuadrantes Scatter cushions 4(40x40) - 2(60x60)

Sofá 3 Sofa 3

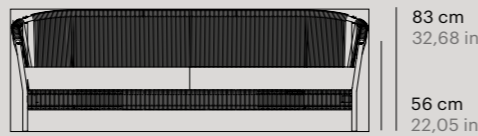

220,5 cm
86,81 in

83 cm
32,68 in

56 cm
22,05 in

Ref. 78149

Peso Weight 48,5 Kg 106,9 lb
m³ 1,62 m³
Cuadrantes Scatter cushions 5(40x40) - 3(60x60)

Weave

Vicent Martínez

p. 60

Tumbona redonda Rounded sunbed



163 cm
64,17 in

40 cm
15,75 in

175 cm
68,90 in

76 cm
29,92 in

45,5 cm
17,91 in

Ref. 78195

Peso Weight 72,7 Kg 160,3 lb
m³ 2,51 m³
Cuadrantes Scatter cushions 2 (40x40) - 3 (50x50) - 4 (60x60)

Sillón reclinable Reclining armchair



85 cm
33,5 in

33 cm
13 in

120 cm
47,2 in

85 cm
33,5 in

52 cm
20,5 in

Ref. 77198

Peso Weight 30,5 Kg 67 lb
m³ 0,653 m³
Cuadrantes Scatter cushions 1 (40x40)



Puff Ottoman



78 cm
30,7 in

78 cm
30,7 in

33 cm
13 in

Ref. 77155

Peso Weight 15,2 Kg 33 lb
m³ 0,25 m³

Tumbona Sunbed



190 cm
74,8 in

33 cm
13 in

91 cm
35,8 in

78 cm
30,7 in

Ref. 77195

Peso Weight 42,5 Kg 93 lb
m³ 0,66 m³



Brazo tumbona Sunbed arm



35 cm
13,8 in

26 cm
10,2 in

15 cm
5,9 in

Ref. 77194

Peso Weight 2,5 Kg 5 lb
m³ 0,01 m³

Materiales Materials

Estructura Frame
Aluminio pintado en polvo
Powder coated aluminum

Trenzado Weaving
Cuerda Ø 8 mm
Rope Ø 8 mm

Acabados Finishes

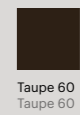
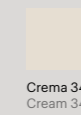
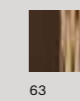
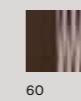
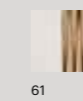

Acabados brazo tumbona Sunbed arm finishes

Weave

Vicent Martínez

p. 60

Columpio Swing

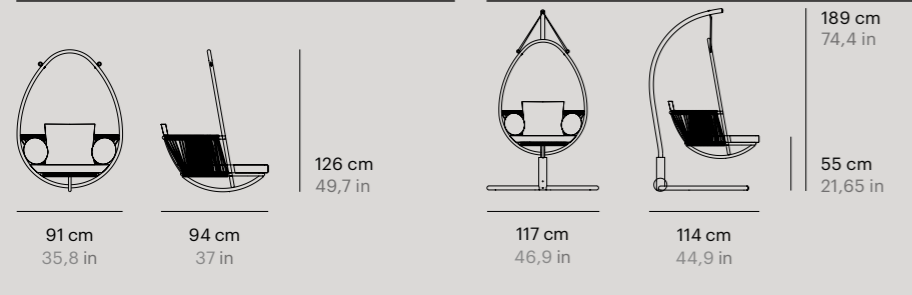

Ref. 77192

Peso Weight 16,5 Kg 36 lb
m³ 1,21 m³
Cuadrantes Scatter cushions 2 (Ø 32) - 1 (60 x 45)

Ref. 77193

Peso Weight 32 Kg 70 lb
m³ 1,50 m³
Cuadrantes Scatter cushions 2 (Ø 32) - 1 (60 x 45)

Mesa centro redonda Rounded coffe table

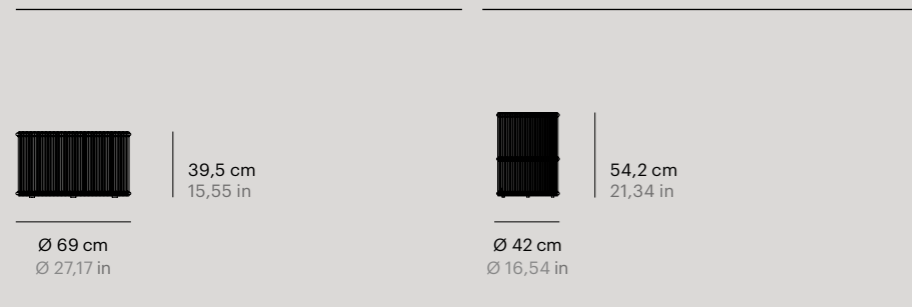

Ref. 78153

Peso Weight 16 Kg 35,2 lb
m³ 0,25 m³

Ref. 78156

Peso Weight 9 Kg 19,8 lb
m³ 0,13 m³

Materiales Materials

Estructura Frame
Aluminio pintado en polvo
Powder coated aluminum

Trenzado Weaving
Cuerda Ø 8 mm
Rope Ø 8 mm

Tapa mesa Table top
Compacto
HPL

Acabados Finishes

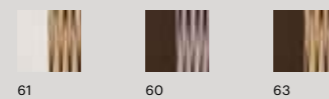

Acabados tapa mesa compacto HPL table top finishes

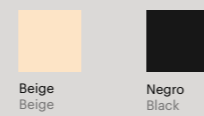

Weave

Vicent Martínez

p. 60

Pie mesa centro 4 patas Coffee table base 4 legs

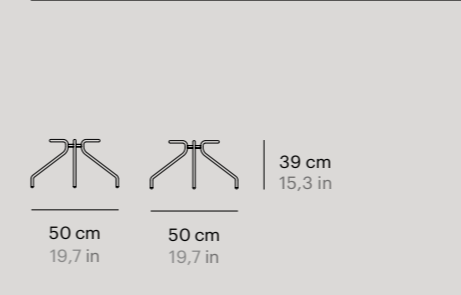

Ref. 77158

Peso Weight 6 Kg 13 lb
m³ 0,12 m³

Pie mesa alta 4 patas High table base 4 legs

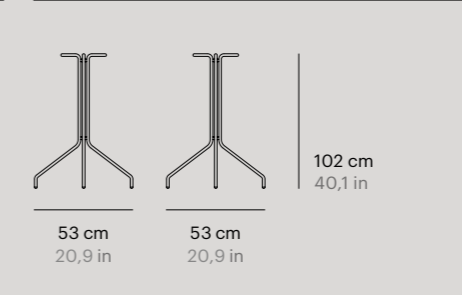

Ref. 77112

Peso Weight 12 Kg 26 lb
m³ 0,34 m³

Pie mesa 4 patas Table base 4 legs

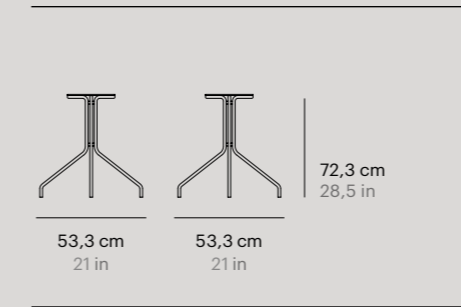

Ref. 77115

Peso Weight 10,5 Kg 23 lb
m³ 0,28 m³

Pie mesa doble 4 patas Double table base 4 legs

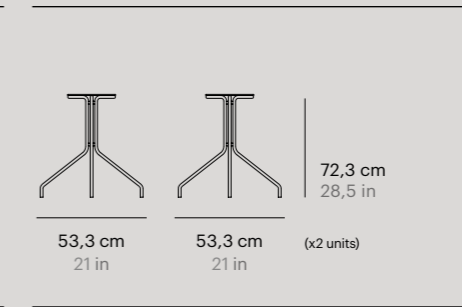

Ref. 77109

Peso Weight 21 Kg 46 lb
m³ 0,56 m³

Materiales Materials

Estructura Frame
Aluminio pintado en polvo
Powder coated aluminum

Acabados Finishes



Compact

p. 60

Tapa compacto HPL top



Ref. 74314

Peso Weight 8 Kg 17 lb
m³ 0,04 m³

Tapa compacto HPL top



Ref. 74309

Peso Weight 10 Kg 22 lb
m³ 0,05 m³

Tapa compacto HPL top



Ref. 74307

Peso Weight 12 Kg 26 lb
m³ 0,06 m³

Tapa compacto HPL top

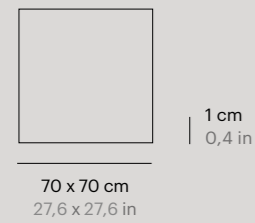

Ref. 74315

Peso Weight 10 Kg 22 lb
m³ 0,04 m³

Tapa compacto HPL top

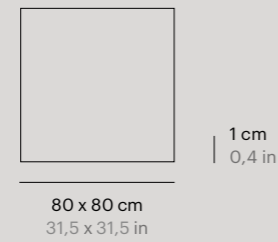

Ref. 74310

Peso Weight 11,5 Kg 25 lb
m³ 0,05 m³

Tapa compacto HPL top

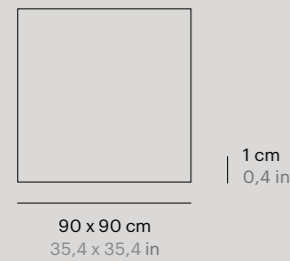

Ref. 74311

Peso Weight 13 Kg 28 lb
m³ 0,06 m³

Tapa compacto HPL top

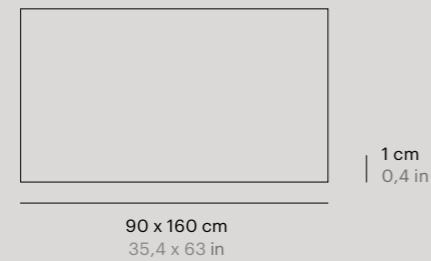

Ref. 74308

Peso Weight 22,5 Kg 49 lb
m³ 0,11 m³

Materiales Materials

Tapa Top
Compacto
HPL

Acabados Finishes

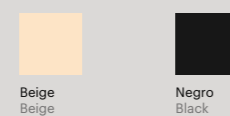

Weekend

Juan Santos

p. 160

Silla texiline Chair texiline

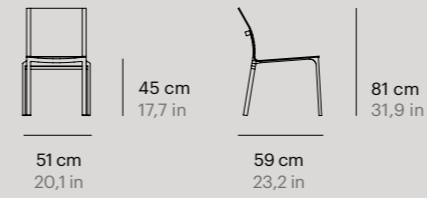

Ref. 73102

Peso Weight 8 Kg (1pc) 17 lb (1pc)
17 Kg (4pc) 37 lb (4pc)
m³ 0,23 m³ (1pc) - 0,54 m³ (4pc)

Sillón texiline Armchair texiline

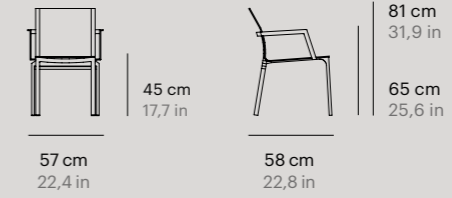

Ref. 73103

Peso Weight 9,5 Kg (1pc) 20 lb (1pc)
22 Kg (4pc) 48 lb (4pc)
m³ 0,40 m³ (1pc) - 0,48 m³ (4pc)

Sillón Armchair

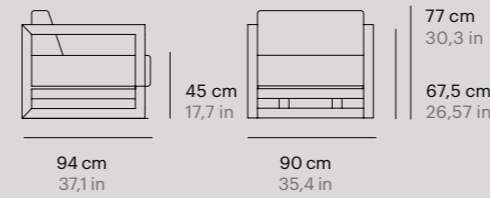

Ref. 73145

Peso Weight 34,6 Kg 76,3 lb
m³ 0,86 m³
Cuadrantes Scatter cushions 1 (50x50)

Sofá 2 Sofa 2

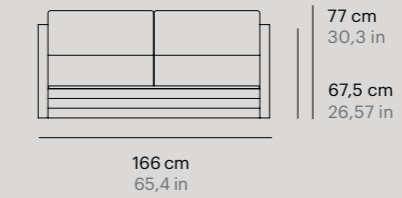

Ref. 73147

Peso Weight 62 Kg 136,7 lb
m³ 1,29 m³
Cuadrantes Scatter cushions 2 (50x50)

Sofá 3 Sofa 3

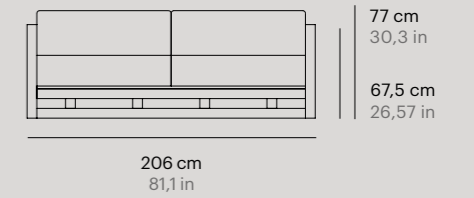

Ref. 73149

Peso Weight 75 Kg 165,3 lb
m³ 1,66 m³
Cuadrantes Scatter cushions 3 (50x50)

Tumbona Sunbed

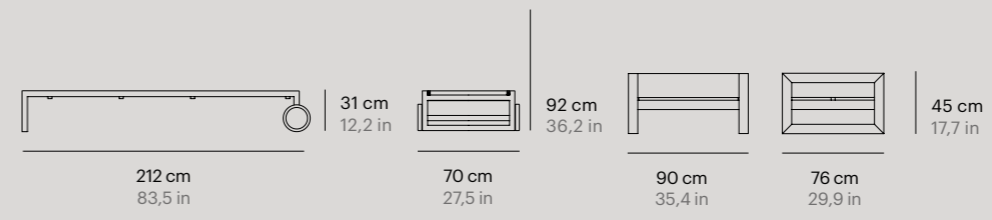

Ref. 73198

Peso Weight 23,4 Kg 51,6 lb
m³ 0,76 m³

Puff Ottoman

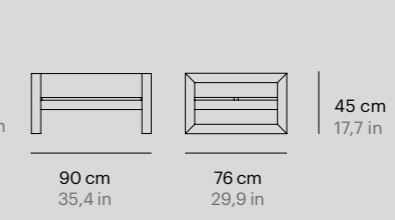

Ref. 73152

Peso Weight 28,8 Kg 63,5 lb
m³ 0,48 m³

Materiales Materials

Estructura Frame
Aluminio pintado en polvo
Powder coated aluminum

Telas Fabrics
Batyline

Acabados estructura Structure finishes



Acabados telas Fabrics finishes

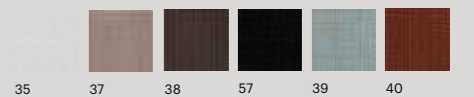

Weekend

Juan Santos

p. 160

Mesa auxiliar Auxiliar table

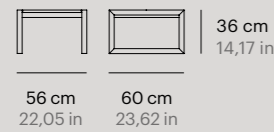

Ref. 73159

Peso Weight 12 Kg 26,5 lb
m³ 0,17 m³

Mesa centro Coffee table

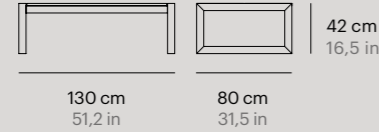

Ref. 73154

Peso Weight 35 Kg 77,2 lb
m³ 0,56 m³

Mesa rincón Corner table

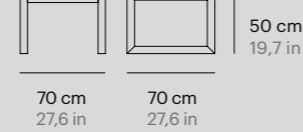

Ref. 73156

Peso Weight 20,8 Kg 45,96 lb
m³ 0,48 m³

Mesa comedor Dining table

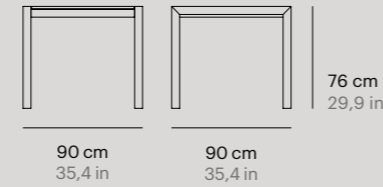

Ref. 73110

Peso Weight 30,6 Kg 67,5 lb
m³ 0,86 m³

Mesa comedor Dining table

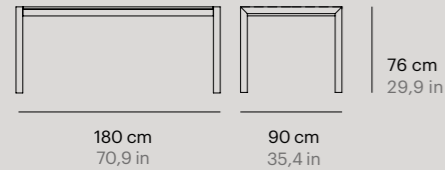

Ref. 73109

Peso Weight 59,30 Kg 130,6 lb
m³ 2 m³

Mesa comedor Dining table

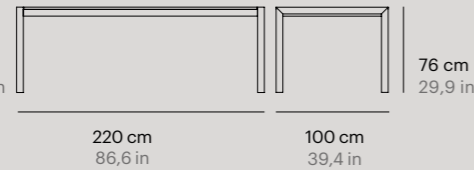

Ref. 73108

Peso Weight 65,36 Kg 143,9 lb
m³ 2 m³

Mesa extensible Extendable table



Ref. 73107

Peso Weight 100 Kg 220,5 lb
m³ 2 m³

Materiales Materials

Estructura Frame
Aluminio pintado en polvo
Powder coated aluminum

Tapa Top
Polietileno Polyethylene

Acabados estructura Frame finishes



Acabados tapa Top finishes

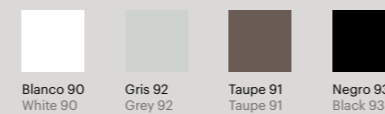

Beach

POINT Studio

p. 212

Parasol Umbrella

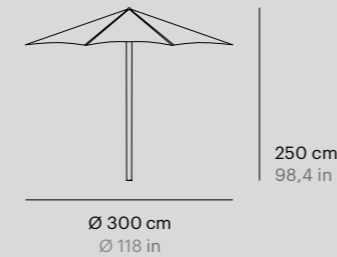

Ref. 84602

Peso Weight 13,4 Kg 29,5 lb
m³ 0,20 m³

Parasol Umbrella

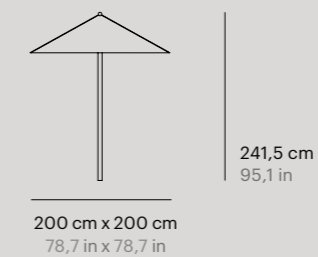

Ref. 84601

Peso Weight 6,4 Kg 14,1 lb
m³ 0,14 m³

Materiales Materials

Estructura Frame
Aluminio lacado
Lacquered aluminum

Telas Fabrics
Grupo 1-21 Group 1-21
Batylene

Estructura Frame
Aluminio + varillas fibra de vidrio
Aluminum + glass fiber ribs

Telas Fabrics
Grupo 1-21 Group 1-21
Batylene

Acabado estructura Frame finish

Aluminio lacado blanco
White lacquered aluminum

Acabados telas Fabrics finishes

Base de parasol Umbrella base

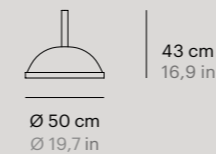

Ref. 84603

Peso Weight 39 Kg 85 lb
m³ 0,15 m³

Base de parasol Umbrella base

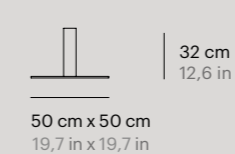

Ref. 84604

Peso Weight 31 Kg 68 lb
m³ 0,11 m³

Materiales Materials

Estructura Frame
Aluminio lacado + hormigón
Lacquered aluminum + concrete

Estructura Frame
Acero galvanizado
Galvanized steel

Acabado estructura Frame finish

Aluminio lacado blanco
White lacquered aluminum

Ombra

 POINT Studio

p. 212

Parasol Umbrella

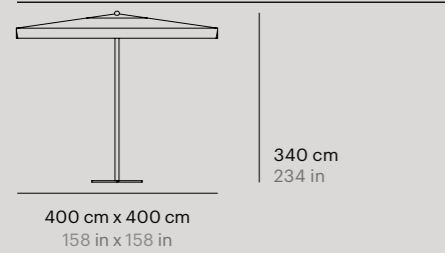

Ref. 84804

Peso Weight 194 Kg 427 lb
m³ 0,40 m³

Materiales Materials

Estructura Frame
Aluminio lacado
Lacquered aluminum
Telas Fabrics
Grupo 1-21 Group 1-21
Batylne

Acabado estructura
Frame finish

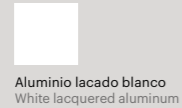

Acabados telas Fabrics finishes



Base de parasol Umbrella base



107 cm x 107 cm
42,1 in x 42,1 in

Peso Weight 168,5 Kg 371 lb
m³ 0,16 m³

Estructura Frame
Aluminio lacado
Lacquered aluminum

Materiales Materials
4 baldosas de cerámica de 35 kg cada una
4 ceramic tiles 77 lb each one

Roma

 POINT Studio

p. 212

Parasol Umbrella

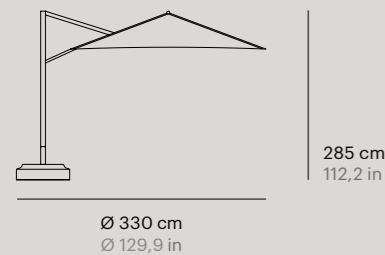

Ref. 84701

Peso Weight 56,3 Kg 124,2 lb
m³ 0,40 m³

Parasol Umbrella

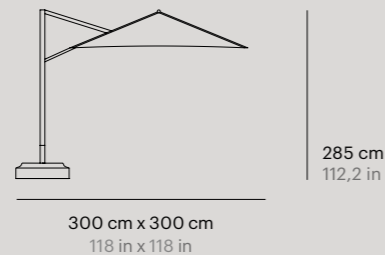

Ref. 84703

Peso Weight 64,5 Kg 142,2 lb
m³ 0,40 m³

Parasol Umbrella

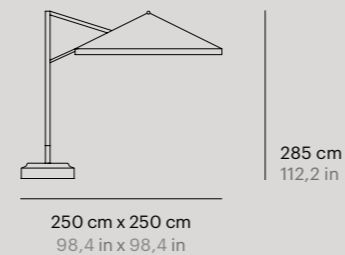

Ref. 84702

Peso Weight 58 Kg 127,9 lb
m³ 0,40 m³

Materiales Materials

Estructura Frame
Aluminio lacado
Lacquered aluminum
Telas Fabrics
Grupo 1-21 Group 1-21
Batylne

Acabado estructura Frame finish

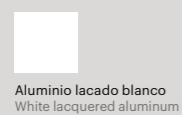

Acabados telas Fabrics finishes

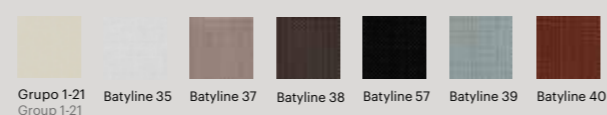

Roma

 POINT Studio

p. 212

Base de parasoles Umbrella base

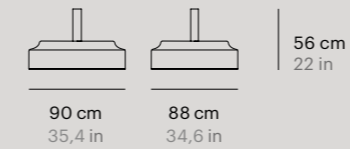

Peso Weight 33 Kg sin arena 72 lb without sand
132 Kg con arena 291 lb with sand
m³ 0,16 m³

Materiales Materials

Estructura Frame
Aluminio lacado
Lacquered aluminum

Patas Legs
Pvc con ruedas
Pvc with wheels

Covers

Funda adaptada para cada modelo
Cover adapted to each model



MATERIAL DE TEJIDO BASE

Hilo
Tejido
Acabado Finish

Peso Weight
Resist. al frío Cold resist.
Resist. al calor Heat resist.
Resist. a la interperie

pes din en iso 2076
370/540 dtex din en iso 2060
1/1
tratamiento fungicida, repelente
a la suciedad
240g/m² en iso 2286-2
-25°C en 1876-1
+70°C pa 07.04 (intern)
6-8 note, value en iso 105 b04

Accesories

Cubeta adaptada a cada jardinera
Tray adapted to each planter



Lámparas MIST
MIST Lamps



Material Aluminio
Material Aluminum

Potencia Power 6* 1 W
LED chip bridgelux
Voltaje de entrada Input voltage 85-240VAC. 50-60 hz.Cable 2 meters + EU plug
CCT warm white (2800 - 3000 k)

Ángulo de haz Beam angle

60 degree
all stainless steel body
IP67
sistema estanco
stanco system

9* 1 W
bridgelux
85-240VAC. 50-60 hz.

2 meters + EU plug
warm white (2800 - 3000 k)
60 degree
all stainless steel body
IP67
sistema estanco
stanco system

SÍMBOLOS SIMBOLS

Apilable
Stacking

Patas regulables
Adjustable legs

Abatible
Swing

Ruedas
Wheels

Finishes and
maintenance

Aluminio Aluminum

Es el material utilizado en estructuras y patas de los muebles. Se utilizan perfiles de diversas formas y medidas. Los espesores varían entre 0,5-2,5 mm dependiendo de la zona donde se aplique. Para zonas de mayor resistencia y tensión, como pueden ser patas, brazos y refuerzos, se utiliza el mayor espesor.

This is the material used in the structure and leg of furniture. Profiles of various shapes and sizes are used. Thicknesses range from 0,5 to 2,5 mm, depending on the area where it is applied. For those areas which endure greater strength and stress, such as legs, arms and reinforcements, a greater thickness is used.

Aluminio pintado en polvo Powder coated aluminum

Con resina epóxica como ligante, para incrementar la resistencia a la corrosión, abrasión y a los agentes químicos.

With epoxy resin as a binder to increase resistance to corrosion, abrasion and chemical agents.

70 Blanco nieve 70 White snow	34 Crema 34 Cream	03 Tostado 03 Toasted
74 Arena 74 Sand	75 Óxido 75 Oxide	60 Taupe 60 Taupe
56 Gris metalizado 56 Gunmetal grey	59 Dark 59 Dark	72 Terracota 72 Terracotta
73 Verde ficus 73 Green ficus	71 Azul cielo 71 Blue sky	

Aluminio anodizado Anodized aluminum

El aluminio se somete a un proceso electrolítico, es recubierto con una capa que le brinda una gran protección ante las amenazas del medio ambiente.

Aluminium undergoes an electrolytic process, is coated with a layer that provides great protection against environmental threats.



Limpieza y mantenimiento Maintenance and cleaning

Utilizaremos bayetas suaves o esponjas que no rayen la superficie y agua con jabón o detergentes neutros diluidos en agua; nunca productos abrasivos. Después se enjuagará con agua limpia y se secará con un paño, para evitar que el detergente afecte al material.

Use soft cloths or sponges that will not scratch the surface with soap and water or neutral detergents, diluted in water; never use abrasives. It is then rinsed with clean water and dried with a cloth to prevent the detergent from affecting the material.

Acero Inoxidable Stainless Steel

Se utiliza la aleación 304L, que es un acero inoxidable austenítico. Acabado electropulido que le proporciona mayor resistencia a la corrosión.



An 304L alloy, which is an austenitic stainless steel, is used. Electropolished finish that provides greater resistance to corrosion.

Limpieza y mantenimiento Maintenance and cleaning

Polvo y suciedad: lavar con agua y detergente de PH neutro. Áreas oxidadas: solución de Ácido nítrico al 20% y agua.

Dust and dirt: Wash with water and neutral PH detergent. Oxidized areas: 20% solution of Nitric Acid and water.

Compacto HPL

Es el material de las tapas de las mesas de algunas colecciones. Se trata de tablero compacto de 10 mm de espesor en calidad standard (CGS) termoendurecido a alta presión en formato 4200 x 1600 mm con el núcleo compuesto de resinas fenolicas y superficies decorativas impregnadas en resinas melamínicas.

This is the material used for the table tops of some collections. It is a 10 mm thick, compact board in standard quality (CGS), which was thermoset at high pressure and in a 4200x1600 mm format, with a core which is made of phenolic resins and decorative surfaces that are impregnated with melamine resins.

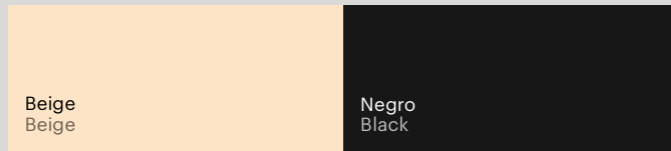

Limpieza y mantenimiento Maintenance and cleaning

Las superficies de compacto deben limpiarse con regularidad pero no requieren ningún mantenimiento especial, solo un paño húmedo con agua templada o detergente suave. Se pueden usar perfectamente casi todos los productos de limpieza o desinfectantes domésticos siempre y cuando estos no sean abrasivos o altamente alcalinos.

Surfaces made out of HPL material should be regularly cleaned and do not require any special maintenance; just wipe with a damp cloth that has been previously soaked in lukewarm water with a gentle detergent. Almost all kinds of cleaning products can be perfectly used as long as they are not abrasive or highly alkaline.

Teca Teak

Point utiliza madera teca de grado A, de origen asiático. Contiene un alto nivel de aceite y gomas naturales, esto le da una alta flexibilidad y durabilidad.



Point uses grade-A teak wood of Asian origin. Contains a high level of oil and natural rubbers, which provides it with great flexibility and durability.



Merbau Merbau

Madera procedente del sudeste de Asia y Oceanía. Es moderadamente pesada y dura. Tiene una resistencia mediana a las torceduras y buena resistencia a los golpes.



Wood from south-east Asia and Oceania. It is moderately heavy and hard. It has an average kink resistance and a good resistance to shocks.

Limpieza y mantenimiento Maintenance and cleaning

Si el mueble de Teca o Merbau ha estado expuesto a los elementos y se deja sin tratamiento, ambas maderas se enfrentaran a una pátina de color gris plateado después de unos meses. Este cambio en la apariencia de la madera no afecta a la integridad estructural de los muebles. En este caso, únicamente deberá limpiar a fondo una o dos veces al año, con agua tibia y jabón neutro, frotando con una esponja.

Si desea conservar el color dorado-marrón de estas maderas nuevas recomendamos el producto sellador de Point (aceite de teca). Este tipo de productos no afectará a la resistencia o longevidad de los muebles, únicamente a su apariencia. Se recomienda aplicar el sellador de teca dos veces al año aproximadamente.

If Merbau or Teak furniture has been exposed to weather and left untreated, both woods will show a silvery grey patina after a few months. This change in wood appearance does not affect the structural integrity of the furniture. In this case, you only have to clean it thoroughly once or twice a year with warm water and a mild soap, scrubbing it with a sponge.

If you want to preserve the golden-brown colour of these new woods, we recommend the Point sealant (teak oil). This type of product does not affect the strength or longevity of the furniture, only its appearance. It is recommended to apply the teak sealant twice a year or so.

Polietileno Polyethylene

Es el material utilizado en la colección Weekend. Se presenta en planchas de polietileno de alta densidad fabricadas por extrusión, de 2 cm de espesor. Con aditivos UV (protección solar) para que el color no sufra alteraciones. Tanto para los asientos como para tapas de mesas se utilizan planchas de cuatro colores diferentes: blanco, negro, taupe y gris.

This is the material used in the Weekend collection. Its format is high-density polyethylene manufactured under an extrusion process and 2 cm thick. It has UV additives (for solar protection) to ensure that no discolouring takes place. For both the seats and the table tops slabs available in four different colors are utilized: white, black, taupe and grey.

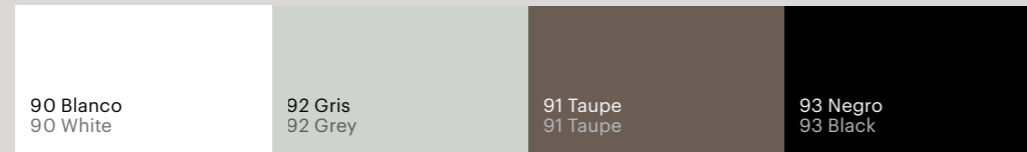

Limpeza y mantenimiento Maintenance and cleaning

El mantenimiento de estos materiales es mínimo ya que no sufren deterioro con el paso del tiempo. Para limpiar basta con pasarle un paño húmedo o aplicar agua y jabón neutro. Para disimular rayas y defectos superficiales puedes utilizar espráis/ líquidos reparadores que se encuentran en el mercado.

Maintenance of these materials is minimal, since they do not deteriorate over time. To clean them, it is enough to pass a damp cloth or apply water and a mild soap. To conceal scratches and surface defects, you can use repairing sprays / liquids found on the market.

Granito Granite

El granito es una roca ígnea de gran belleza y exclusividad. La composición básica del granito es el cuarzo, feldespato y mica, que le confieren una dureza muy alta en la escala de Mohs y una gran resistencia a la abrasión. Es además totalmente reciclable, ecológico y de fácil mantenimiento.

Granite is an igneous rock of great beauty. The flecked look of granites is caused by the presence of mica, quartz and feldspar which produces different size grains, colours and swirls and which give this material such charisma. It is not affected by erosion or climatic changes and is therefore the perfect material for decorating and cladding high transit areas. Granite has a high resistance to abrasion and is totally recyclable, organic and easy to maintain.



Limpeza y mantenimiento Maintenance and cleaning

Para la limpieza del granito simplemente utilizar paño de algodón húmedo con agua.

For cleaning the granite simply use a damp cotton cloth with water.

Porcelánico Porcelanic

Se trata de un material porcelánico elaborado de 12 mm de espesor. Características técnicas: Impermeable y resistente a líquidos, con un nivel de absorción próximo a cero. Resistente al rayado y a la abrasión gracias a la dureza de su superficie. No se quema en contacto con el fuego ni emite humo ni sustancias tóxicas al ser sometido a altas temperaturas. Resistente a cualquier tipo de agente químico de limpieza. No desprende sustancias nocivas. Es totalmente apto para el contacto con los alimentos. Certificado NSF. Siendo 100% natural, los colores no se desvirtúan cuando el material se expone al sol o a condiciones meteorológicas extremas. No desprende ninguna sustancia nociva para el entorno. Hasta un 52% de material reciclado en cada tabla. 100% reciclable. 30 kg/m² en la tabla de 12 mm. Módulo de rotura elevado. Resistente a altas cargas de presión y peso.

Here we are dealing with a 12 mm-thick porcelaneous material. Technical characteristics: Waterproof and resistant to liquids, with an absorption level close to zero. Scratch- and abrasion-resistant thanks to the hardness of the surface. No combustion takes place if in contact with fire and no smoke nor toxic substances are released when it is subjected to high temperatures. Resistant to any type of chemical or cleaning agent. No dangerous substances are given off. It is totally apt for contact with foodstuffs. NSF Certificate. Being 100% natural, colours do not fade when exposed to the sun or subjected to extreme meteorological conditions. No dangerous substances that may harm the environment are given off. Each board contains up to 52% of recycled material. 100% recyclable. 30 kg/m² in a 12 mm board. Module: highly resistant to breakage. Resistant to high pressures and loads.

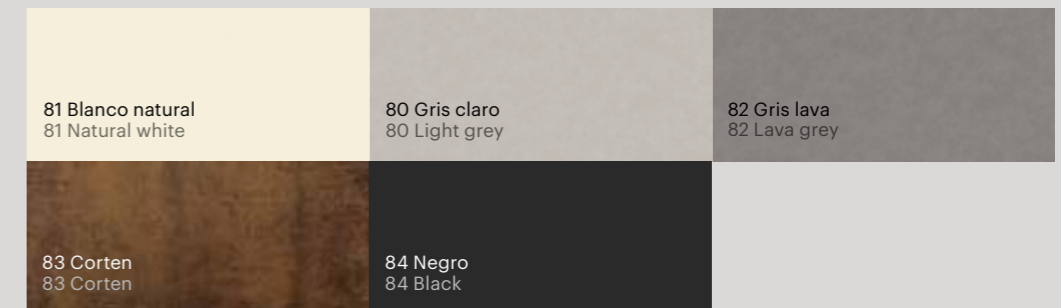

Limpeza y mantenimiento Maintenance and cleaning

Tienen una limpieza bastante fácil, ya que los restos de comida y residuos que se depositen, no pueden penetrar en el material, por lo que garantizan una buena higiene; para la mayoría de los casos, sólo bastará con un paño húmedo para limpiarlo. Use un paño de microfibra para quitar el polvo de la superficie. Se puede lavar con agua tibia, a la cual se le puede agregar un detergente en la dosis de uso recomendado por el fabricante. (Deben evitarse productos que contengan ácido fluorhídrico y sus derivados). Enjuagar con agua tibia y secar con bayetas o algo similar.

Quite easy to clean, as traces of foodstuffs and other residues that may be deposited cannot penetrate the material and therefore hygiene is highly enhanced; in most cases, a damp cloth is sufficient to wipe-clean the surface. Use a microfibre cloth to dust the surface. To wash, use lukewarm water; a detergent may be added according to the dosage recommended by the manufacturer. (products containing fluorhydric acid and its derivatives should be avoided). Rinse with lukewarm water and dry with a cleaning cloth or similar.

**Cristal
Glass**

Cristales templados de seguridad. Dureza de 6 a 7 en la escala Mohs. Resistencia a la mayoría de agentes químicos, excepto el ácido hidrofúorhídrico.

Tempered safety glass. Hardness of 6 to 7 on the Mohs scale. Resistance to most chemicals, except for hydrofluoric acid.



**Limpieza y mantenimiento
Maintenance and cleaning**

Para eliminar los restos de suciedad de las tapas de cristal bastará con ayudarnos de un trapo que no deje pelusa y cualquier producto limpiacristales, o bien preparar una solución de agua, amoníaco y alcohol.

To remove dirt from glass tops, you will simply need a lint-free cloth and any glass cleaner or prepare a solution with water, ammonia and alcohol.

**Cuerda
Rope**

Tanto el ánima como el recubrimiento del cordón, es de polyester texturizado de fibra cortada. Para conseguir una mayor solidez a la luz e intemperie, el proceso de tintura es AUTO y además lleva un filtro de color para mayor fijación.

Both the bord and the lining of the cord are textured polyester of cut fiber. To achieve a greater fastness to the light and weather, the dyeing process is AUTO and also includes a color filter for more fixing.



Turrón
Nougat

Taupe
Taupe

**Limpieza y mantenimiento
Maintenance and cleaning**

Utilizar solución jabonosa de PH neutro para la limpieza de residuos o manchas. Evitar el contacto con productos abrasivos (lejías, cloro, aceites, productos con ácidos o sustancias corrosivas en su composición).

A soapy solution of neutral PH can be used to clean residues or spots. Avoid contact with abrasive products (bleach, chlorine, oils, any product including corrosive acids or substances in its composition).

**Shintotex®
Advanced synthetic fibres**

Es la nueva fibra sintética para muebles de exterior, inspirada en la naturaleza y perfeccionada técnicamente hasta alcanzar el máximo nivel de confort, funcionalidad y durabilidad. El shintotex está compuesto por PP y PE más componentes catalizadores como filtros UV, pigmentos, aditivos anti-estáticos y elementos plastificantes.

It is a new synthetic fibre for outdoor furniture, inspired by nature and perfected by technology to achieve maximum comfort, functionality and durability. The Shintotex is made of PP and PE, as well as catalysts, such as UV filters, pigments, additives, anti-statics and plasticisers.

Características Técnicas:

Resistencia a cambios climatológicos.
Resistencia a agentes químicos abrasivos.
Resistencia a rotura y deterioro por el uso.
Alta flexibilidad.
Total reciclaje.

Technical Features:

Resistant to weather changes.
Resistant to abrasive chemical agents.
Resistant to breakage and wear & tear.
Highly flexible.
Fully recyclable.

Características Estéticas:

Calidez y apariencia natural.
Tacto agradable.
Variedad de texturas y trenzados.
Fácil limpieza.
Mayor ligereza.

Aesthetical Features:

Warmth and nature appearance.
Pleasant to the touch.
Variety of textures and braids.
Easy to clean.
Lighter.



Flat oval 6 mm
36 Marfil Ivory

Flat oval 6 mm
03 Tostado Toasted

Flat oval 6 mm
59 Dark

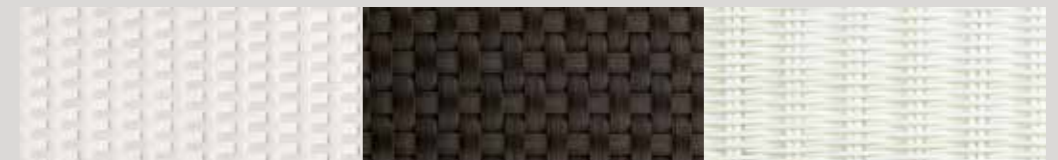

Flat 7 mm
35 Blanco White

Flat 9 mm
59 Dark

Round 3-4 mm
36 Marfil Ivory



Round 3-4 mm
03 Tostado Toasted

Round 3-4 mm
10 Multicolor

Round 3-4 mm
59 Dark

**Limpieza y mantenimiento
Maintenance and cleaning**

Pasar cepillo de cerdas suaves sobre el tejido para eliminar el polvo, o utilizar solución jabonosa de PH neutro para la limpieza de residuos o manchas. Evitar el contacto con productos abrasivos (lejías, cloro, aceites, productos con ácidos o sustancias corrosivas en su composición).

Use a brush of smooth bristles in order to eliminate the dust from the weaving. Also, a soapy solution of neutral PH can be used to clean residues or spots. Avoid contact with abrasive products (bleach, chlorine, oils, any product including corrosive acids or substances in its composition).

Telas Grupo I
Fabrics Group I

Composición: 100% Acrílico teñido en masa
Ancho: 160cm
Acabado: con tratamiento antimanchas y antihongos. Acabado teflón. Evita la condensación de calor y humedad. Buena repelencia al aceite.
Solidez a la luz: 7/8
Garantía: 5 años
Tolerancia: Valores susceptibles de tolerancia de +/- 5%

Composition: 100% Solution Dyed Acrylic
Width: 160cm
Finish: with stain and mildew resistant treatment. Teflon finish. Avoid condensation from hot and humidity. Good oil repellency.
Light fastness: 7/8
Warranty: 5 years
Tolerance: Sensitive values of tolerance of +/- 5%

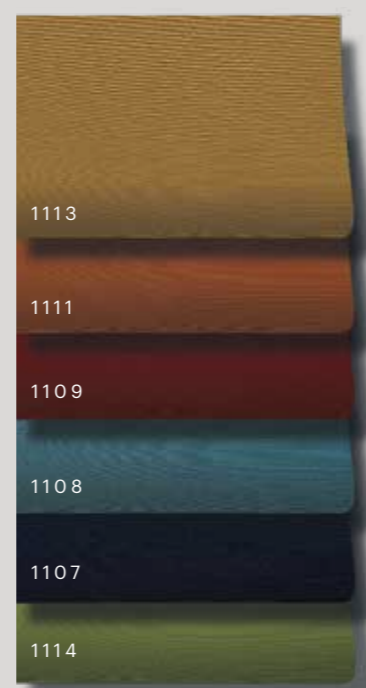

Limpieza y mantenimiento
Maintenance and cleaning



Eliminar la suciedad mediante cepillado o aspirado suave del tejido. Lavar a temperatura máxima de 30° y jabón neutro. No utilizar disolventes ni detergentes abrasivos. No utilizar secadora. Planchado máximo a 150°. No admite lavado en seco.

Remove dirt by softly brushing or vacuuming the tissue. Wash at 30° max. with a mild soap. Do not use solvents or abrasive detergents. Do not tumble dry. Ironing up to 150° max. Dry cleaning is not allowed.

Certificados
Certificates



Telas Grupo II
Fabrics Group II

Composición: 100% Acrílico teñido en masa
Ancho: 137cm EN 1773
Acabado: repelente al agua y antimanchas.
Solidez a la luz: 8/8 (ISO 105 B02).
Solidez de colores a la intemperie: 4-5/5 (ISO 105 B04).
Garantía: 5 años

Composition: 100% Solution Dyed Acrylic.
Width: 137 cm EN 1773.
Finish: water-repellent and stain-proof.
Light fastness: 8/8 (ISO 105 B02)
Weather condition color fastness: 4-5/5 (ISO 105 B04).
Warranty: 5 years



Limpieza y mantenimiento
Maintenance and cleaning



Textiles Sunbrella pueden lavarse a máquina a 40°. Dejar secar al aire. Las tapicerías de tela que no se puedan quitar para el lavado se pueden limpiar con un cepillo y agua jabonosa de cerdas suaves (agregar 50 ml de lejía por litro de agua en caso de manchas difíciles). Enjuague con agua limpia y dejar secar al aire.

Sunbrella fabrics can be machine washed at 40°. Let air dry. Fabric covers that cannot be removed for washing can be cleaned with a soft-bristle brush and soapy water (add 50 ml of bleach per liter of water in case of tough or stubborn stains). Rinse with clear water and let air dry.

Propiedades
Properties

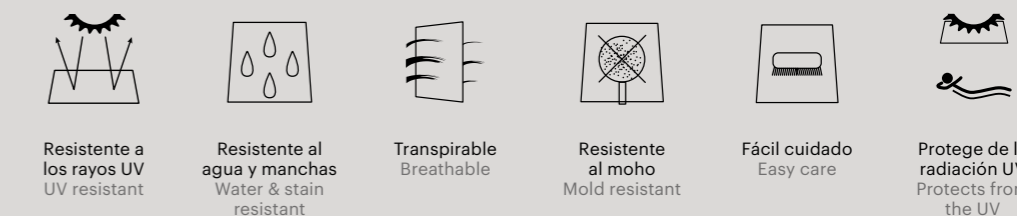

Este grupo de telas Sunbrella combinan hasta 50% de fibra Sunbrella reciclada post-industrial con fibra Sunbrella virgen para asegurar un rendimiento excelente con un mínimo de residuos.

This group of Sunbrella fabrics combine up to 50% post-industrial recycled Sunbrella fiber with virgin Sunbrella fiber to ensure excellent performance with minimal waste.

Telas Grupo II
Fabrics Group II

Composición: 100% Acrílico teñido en masa
Ancho: 160cm
Acabado: con tratamiento antimanchas y antihongos. Acabado teflón. Evita la condensación de calor y humedad. Buena repelencia al aceite. Solidez a la luz: 7/8
Garantía: 5 años
Tolerancia: Valores susceptibles de tolerancia de +/- 5%

Composition: 100% Solution Dyed Acrylic
Width: 160cm
Finish: with stain and mildew resistant treatment. Teflon finish. Avoid condensation from hot and humidity. Good oil repellency. Light fastness: 7/8
Warranty: 5 years
Tolerance: Sensitive values of tolerance of +/- 5%



Limpieza y mantenimiento
Maintenance and cleaning



Eliminar la suciedad mediante cepillado o aspirado suave del tejido. Lavar a temperatura máxima de 30° y jabón neutro. No utilizar disolventes ni detergentes abrasivos. No utilizar secadora. Planchado máximo a 150°. No admite lavado en seco.

Remove dirt by softly brushing or vacuuming the tissue. Wash at 30° max. with a mild soap. Do not use solvents or abrasive detergents. Do not tumble dry. Ironing up to 150° max. Dry cleaning is not allowed.

Certificados
Certificates



BATYLINE
BATYLINE

Composición: Composite PVC – fibras sintéticas
Ancho: 180cm
Garantía: 5 años
Reciclabilidad: 100% por el sistema Texyloop
Sistema de gestión de calidad: ISO 9001
Sistema de gestión medioambiental: ISO 14001

Composition: Composite PVC-synthetic fibres
Width: 180cm
Warranty: 5 years
Recyclability: 100% by Texyloop method
Quality system: ISO 9001
Environmental system: ISO 14001

Grupo II
Group II



Grupo III
Group III



BATYLINE **TEXYLOOP** **Serge Ferrari**

Propiedades
Properties



Resistente al desgarro
Tearing strength resistant



Fácil cuidado
Easy care



Resistente a los rayos UV
UV resistant

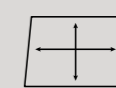

Resistente a la deformación
Deformation resistance



Resistente al moho
Mold resistant

Art Direction & Layout
PABLO GIRONÉS_OFFICE

Photography
MONTSE GARRIGA
ÁNGEL SEGURA FOTO

Dalmatia House
MARIÀ CASTELLÓ ARCHITECTURE
www.m-ar.net

POINT, S.L.
Partida Planet, s/n.
03727 Jalón (Alicante) Spain
T. +34 966 480 132
Fax +34 966 480 358
info@point-sl.com
www.point1920.com

POINT.